

**HEWITT** PARTS AND ACCESSORIES



**HEWITT**  
PARTS AND ACCESSORIES

## Hewitt Accessories — tailor-made appearance and performance

Hewitt Manufacturing produces many different types of docks and lifts to satisfy individual needs, but that's only the beginning. Hewitt accessories offer even greater flexibility with a wide range of equipment designed to simplify installation, automate operation, improve accessibility, enhance appearance, add functionality and provide extra protection for you and your watercraft. While the products shown in this catalog are specifically selected and made to compliment Hewitt Lifts and Docks, many may be used in combination with other brands. Either way, you can be assured that when you choose Hewitt accessories, you are getting the same high-quality materials and workmanship that make Hewitt Lifts and Docks the most durable designs in the industry.



# CONTENTS

<b>4</b>	Sectional Dock System	<b>15</b>	Dock Storage Boxes & Helper Wheels	<b>26</b>	Heavy Duty Electric Hoists
<b>5</b>	Hinges and Connection Clamps	<b>16</b>	Ladders	<b>27</b>	AC/DC Hewitt <sup>2</sup> Electric Hoists
<b>6</b>	Benches & Umbrellas	<b>17</b>	Steps & Stairs	<b>28</b>	Solar Panels & Battery Stands
<b>7</b>	Seawall Brackets & Pole Cross Braces	<b>18</b>	Dock Floats	<b>29</b>	Canopy Accessories
<b>8</b>	Pads, Augers & Pole Brackets	<b>19</b>	Raft Anchor & Anchor Attachments	<b>30</b>	Lift Wheels
<b>9</b>	Stand Pipe, Caps, Post Ratchet, Cleats & Solar Lights	<b>20</b>	Pontoon Conversions	<b>31</b>	Lift Bunks
<b>10</b>	Rub Rail & Side Bumpers	<b>21</b>	Pontoon Beds & Narrow Pontoon Accessories	<b>32</b>	Lift Legs & Extensions
<b>11</b>	Dock Bumpers & Bumper Screws	<b>22</b>	Lift Bumpers, Centering Guides & Motor Stop	<b>33</b>	Hydraulic Pump Box Stands & Leveling Legs
<b>12</b>	Dock Ramps	<b>23</b>	Full Length Guides & Bowstop	<b>34</b>	Roll-A-Rail Accessories
<b>13</b>	Dock Triangle Corner Sections	<b>24</b>	Hand Winch	<b>35</b>	Apparel
<b>14</b>	Dock Hitch & Shore Wheels	<b>25</b>	Winch Handles, Winch Wheels & Catwalk	<b>36</b>	Warranty

**All items must be ordered from your local Hewitt dealer. To find a dealer near you, Call: 800-544-2067 Visit: [hewitt-roll-a-dock.com](http://hewitt-roll-a-dock.com)**

All items in this publication are subject to change without notice.

**Ask your local dealer for a color brochure on Hewitt's other fine products:**

Hydraulic Lifts	Cantilever Boat Lifts	Vertical Lifts
Pontoon Lifts	Canopies	Pontoon Legs
Roll-A-Rails	Sectional Docks	Floating Docks
Roll-A-Docks	Swim Rafts	Benches
All-Terrain Adjustable Stairs	Wet-Port	WaveArmor











# Sectional Dock Systems

 Indicates this product is shippable via UPS.

## Sectional Dock

Add your own decking to our permanent aluminum framed dock system.

4' x 8' Frame with 5' support pipes	 part# DSFRAME5	4' x 10' Frame with 5' support pipes	 part# DSFRAME105
4' x 8' Frame with 8' support pipes	 part# DSFRAME8	4' x 10' Frame with 8' support pipes	 part# DSFRAME108
6' x 8' Frame with 5' support pipes	 part# DS6FRAME5	6' x 10' Frame with 5' support pipes	 part# DS6FRAME105
6' x 8' Frame with 8' support pipes	 part# DS6FRAME8	6' x 10' Frame with 8' support pipes	 part# DS6FRAME108

Price includes: Two extruded sides, One 4' or 6' cross arm bracket, Two 1-1/4" aluminum support pipes and Two aluminum mud plates.

## 4' and 6' Turn Arm Bracket









Used to construct right angles, deck peninsulas, or "L" or "T" sections.

4' Turn bracket only	 part# DS103	6' Turn bracket only	 part# DS113
One 5' Aluminum pipe only	 part# DAP5	One 8' Aluminum pipe only	 part# DAP8
4' Turn bracket kit w/5' pipe	 part# DS1035	4' Turn bracket kit w/8' pipe	 part# DS1038
6' Turn bracket kit w/5' pipe	 part# DS1135	6' Turn bracket kit w/8' pipe	 part# DS1138

Price includes: One 4' or 6' turn bracket, One 1-1/4" aluminum pipe and One aluminum mud plate.

## Make your own dock! 4' or 6' Aluminum Cross Arm

Support pieces for dock ends.



4' Cross arm only	 part# DS102	6' Cross arm only	 part# DS107
One 5' Aluminum pipe only	 part# DAP5	One 8' Aluminum pipe only	 part# DAP8
One Aluminum mud plate only	 part# DAMUD	4' Cross arm kit with 5' support pipes	 part# DS1025
4' Cross arm kit with 8' support pipes	 part# DS1028	6' Cross arm kit with 5' support pipes	 part# DS1075
6' Cross arm kit with 8' support pipes	 part# DS1078		

Price includes: One 4' or 6' cross arm bracket, Two 1-1/4" aluminum support pipes and Two aluminum mud plates.



## 4' and 6' End Caps

Closes off dock ends for a more finished look.

4' Cedar	 part# DS121
4' Aluminum	 part# DS122
6' Aluminum	 part# DS6122

## Sectional Starter Piece

Keeps front of dock from sinking into sand.

Starter piece	 part# DS120
---------------	---





**R**oll-A-Dock



**V**ers-A-Dock



**S**ectional



**C**lassic dock



**F**loating Dock



**Piano Hinges** **R** **F**



Our most popular hinge provides good appearance with maximum strength. Piano hinge has a 3-hole bolt pattern.

- 4' aluminum Piano hinge 7-3/8"  part# D1HINAP
- 6' aluminum Piano hinge 7-3/8"  part# D6HINAP
- 8' aluminum Piano hinge 7-3/8"  part# D8HINAP



**Small Heavy Duty Hinges** **R**

Used on longer multi-section Roll-A-Docks over 48' long equipped with two or more wheel bases. Small heavy hinge has a 2-hole bolt pattern.

- 4' aluminum small heavy duty 3-1/4"  part# D1HINAL
- 6' aluminum small heavy duty 3-1/4"  part# D6HINAL



**Large Heavy Duty Hinges** **R** **F**

Used in rough water where up and down flex is needed. Heavy duty hinge has a 3-hole bolt pattern.

- 4' aluminum heavy duty 3-1/4"  part# D1HINAH
- 6' aluminum heavy duty 3-1/4"  part# D6HINAH
- 4' galvanized heavy duty 3"  part# D1HINGH
- 6' galvanized heavy duty 3"  part# D6HINGH

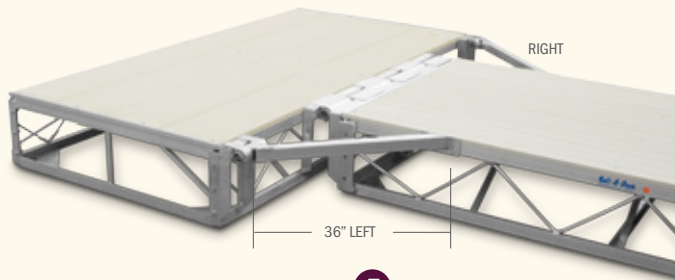

**Corner Support Hinge** **F**

Used with piano hinge to secure fingers or walkways on floating docks. This hinge needs a special plate welded to the dock for mounting.

- Left  part# D1HINACL
- Right  part# D1HINACR



**Vers-A-Dock Corner Pipe Holder** **V**

Used to add a corner post to the Vers-A-Dock.

-  part# DV101



**Connection Clamp** **V** **C**

Used for connecting dock sections together.

-  part# DV102

# Benches, Umbrellas & Brackets...

 Indicates this product is shippable via UPS.

## Bench Seat Options

Available in three colors.



## Free Standing Bench **R S F**

Mounts to any flat surface. All aluminum brackets.  
Shown with aluminum planks. (Umbrella not included.)

- Bench bracket kit (w/bolts, no wood)
- 4' cedar wood bench kit & bolts
- 8' cedar wood bench kit & bolts
- 4' aluminum panel (2" x 6") bench kit & bolts
- 4' aluminum panel (2" x 6") bench kit & bolts (beige)
- 8' aluminum panel (2" x 6") bench kit & bolts
- 8' aluminum panel (2" x 6") bench kit & bolts (beige)

-  part# D1BFA
-  part# D1BFA4C
-  part# D1BFA8C
-  part# D1BFA4A
-  part# D1BFA4AB
-  part# D1BFA8A
-  part# D1BFA8AB







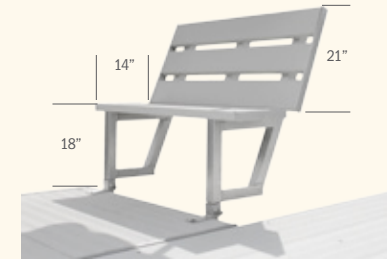

## Offset Bench **R V S C F**

All aluminum construction, Hewitt Benches are unique when mounted to the dock. The bench is over the water, not on the deck, leaving that important deck space.



### Offset Bench for 4' wide docks

- Bench bracket kit (w/bolts, no wood)
- 4' cedar wood bench kit & bolts
- 8' cedar wood bench kit & bolts
- 4' aluminum panel (2" x 6") bench kit & bolts
- 4' aluminum panel (2" x 6") bench kit & bolts (beige)
- 8' aluminum panel (2" x 6") bench kit & bolts
- 8' aluminum panel (2" x 6") bench kit & bolts (beige)

-  part# D1BA
-  part# D1BA4C
-  part# D1BA8C
-  part# D1BA4A
-  part# D1BA4AB
-  part# D1BA8A
-  part# D1BA8AB

*\*if mounting on classic docks with ThruFlow decking please put a "C" before the "B" in the part number. Example: "D1BA" would be "D1CBA"*

### Offset Bench for 6' wide docks



- Bench bracket kit (w/bolts, no wood)
- 4' cedar wood bench kit & bolts
- 8' cedar wood bench kit & bolts
- 4' aluminum panel (2" x 6") bench kit & bolts
- 4' aluminum panel (2" x 6") bench kit & bolts (beige)
- 8' aluminum panel (2" x 6") bench kit & bolts
- 8' aluminum panel (2" x 6") bench kit & bolts (beige)

-  part# D6BA
-  part# D6BA4C
-  part# D6BA8C
-  part# D6BA4A
-  part# D6BA4AB
-  part# D6BA8A
-  part# D6BA8AB

## Bench Umbrella

Aluminum construction, mounts to back of bench. Used to shade the sitting area of your bench, 32" of adjustment.

## Vinyl Umbrella

- 4'  part# D1U4 color
- 8'  part# D1U8 color

## SeaMark Umbrella

- 4'  part# D1US4 color
- 8'  part# D1US8 color

## Standard Vinyl Canopy Colors

Our 16 oz nylon reinforced vinyl canopies are UV resistant to prevent premature fading. Choose from 7 popular colors.



## SeaMark Standard Colors

This 16 oz marine fabric is made from combining Sunbrella fabric with a textured marine grade vinyl. SeaMark fabric has a fluorocarbon finish which makes it UV, water, mildew and fade resist. Choose from 7 popular colors.



## Bench armrest with cup holder

Large 5" x 13-1/2" molded armrest has deep cup holders that are rotational, and can hold up to a 3-1/2" diameter cup.

-  part# D1BAR





**R**oll-A-Dock



**V**ers-A-Dock



**S**ectional



**C**lassic dock



**F**loating Dock

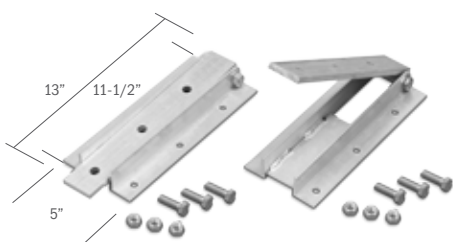

**Hinged Sea Wall Brackets** **R**

For mounting Roll-A-Dock to sea wall face.

part# D1SWBH

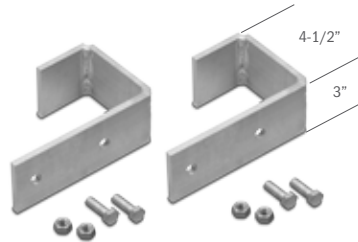

**Hooked Sea Wall Brackets** **R**

Hooks Roll-A-Dock to sea walls up to 4-1/2" thick. Custom sizes available for Vers-A-Dock, Classic and other types of docks. part# D1SWBH

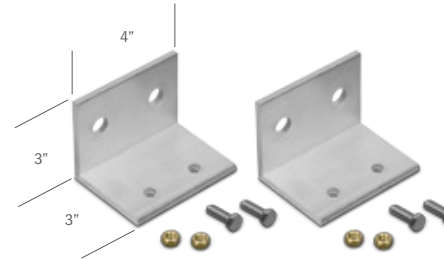

**Sectional Sea Wall Brackets** **S**

Mounts sectional docks to sea walls.

part# D1SWB

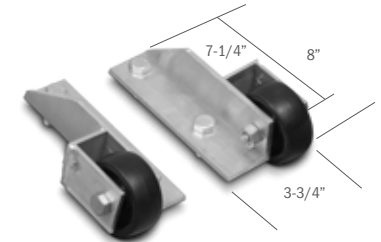

**Dock Rollers** **R** **F**

Allows dock to self-adjust to changing water levels.

part# D1RR

**Plastic Tire** **R** **C**

Polyethylene tire features seamless construction and venting. Plastic tire is 27" tall.

part# DWHEEL



**Dock Crank Handle** **R**

Removable handle to raise and lower the Roll-A-Dock.

part# DHANDLE



**Dock Hole Plug** **R**

Used to plug deck hole when crank handle is removed.

part# DPLUG



**Aluminum Cross Brace Kit**

For more stability in muddy or deep water. Heavy duty extruded ends slide over pipe and secure with large setscrews. (complete X)

Length	ID	Part #	R	V	S	C
5' kit	1-3/4"	DS1095	R	V	S	C
8' kit	1-3/4"	DS108	R	V	S	C
5' kit	2-1/2"	DS1095L	R			
8' kit	2-1/2"	DS108L	R			



**Quick Change Cross Bracing**

Add galvanized steel dock leg bracing from on top of your dock, without going under water, and keeping superior strength with a simple design. Fits pipe up to 1-1/2" OD.

5' Pipe to Frame	part# DV1035	R	V	S	C
6' Pipe to Pipe	part# DV1036	R	S		



# Brackets, Cleats & Caps...

 Indicates this product is shippable via UPS.

## Solar Dock Light **R V S C F**

Solar-powered light uses state-of-the-art technology to store the sun's energy. Easy to install with auto dusk-to-dawn operation and a super durable construction.

Fits 1-5/8", 1-7/8", 2-3/8" OD and 3-1/4" ID Posts.

 part# D1SPL



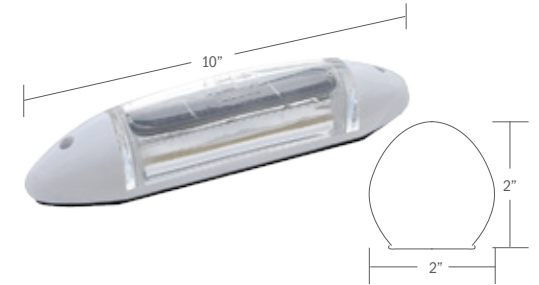

## The H2 L.E.D. **R V S C F**

Solar-powered light uses state-of-the-art technology to store the sun's energy for 8-12 hours of illumination. Made from tough, durable material to stand up to the toughest weather conditions. Easy to install on wood, metal, plastic deck steps or dock surfaces. Installs in just minutes with two stainless steel screws. (included)  part# D1SL



## Aluminum Mud Pads **R F**

1-1/4" Standard 1-3/4" ID  part# DAMUD  
1-1/2" Large 2-1/2" ID  part# DAMUDLG

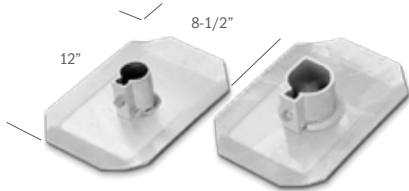

## Mud Auger **R V S C F**

Used to anchor dock supports into the lake bottom. Heavy duty one piece cast iron construction.





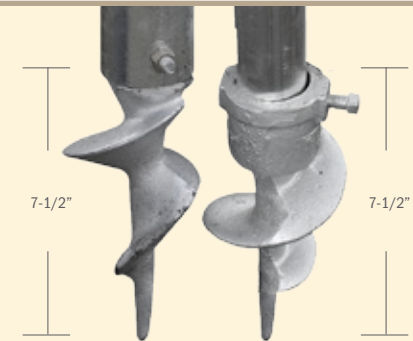

DB800-standard 1-5/8" inside diameter (slides over pipe)  part# DAMUDP

DB903-medium 1-7/8" inside diameter (slides over pipe)  part# DAMUDPM

DB400-large 2" outside diameter (slides inside pipe)  part# DAMUDPLG



## Support Stand Brackets **R F**

Galvanized bracket	ID	Finish	Part#
2" medium	2"	galvanized	 DSBRACM
2-1/2" large	2-1/2"	galvanized	 DSBRACLG
3-1/4" extra large	3-1/4"	galvanized	 DSBRACXL
Aluminum bracket	ID	Finish	Part#
1-1/4" standard	1-3/4"	aluminum	 DABRAC
2-1/2" large short	2-1/2"	aluminum	 DABRACLG
2-1/2" large long	2-1/2"	aluminum	 DABRACLGL

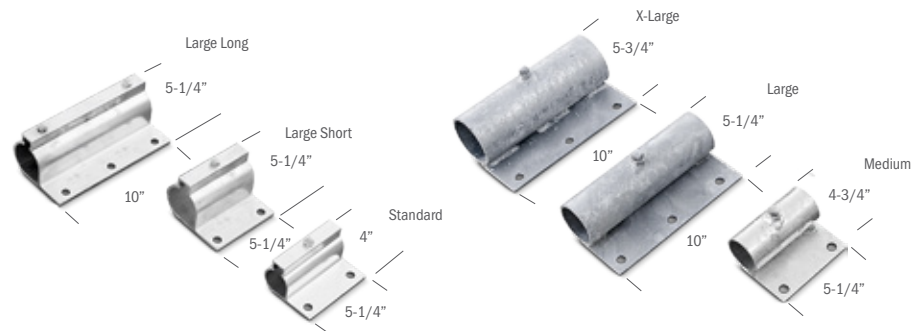





**R**oll-A-Dock



**V**ers-A-Dock



**S**ectional



**C**lassic dock



**F**loating Dock

**Support Stand Pipes** **R V S C F**

Aluminum

ID	OD	5'	8'	10'	12'	21'
1-1/4"	1-1/2"	DAP5	DAP8	DAP10	DAP12	DAP20
<b>Galvanized</b>						
1-1/4"	1-1/2"	DGP51/4	DGP81/4	DGP101/4	DAP121/4	DGP211/4
1-1/2"	1-3/4"	DGP5M	DGP8M	DGP10M	DGP12M	DGP21M
2"	2-1/4"	DGP5L	DGP8L	DGP10L	DGP12L	DGP21L
2-1/2"	2-3/4"	DGP5X	DGP8X	DGP10X	DGP12X	DGP21X



**Dock Cleat Seat** **R V S C F**

Rugged, folding tie-down. Bolts to any flat surface.

**Tinsel Strength:** 27,000 PSI

**Rated for:** 1/2" Rope

**Mounting Hardware:** 1/4" Lag Screw 1/4" Hex Head (not included)

Black part# D1CS  
White part# D1CSW

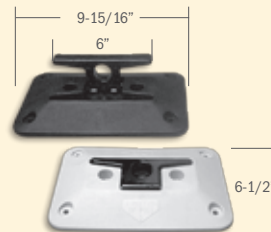

**Dock Cleat Hardware** **R V S C F**

Provides a simple yet secure way to mount your cleats to your dock. (Mounts 4 cleats)

part# D1CSH



**Post Winch Kit** **R V S C F**

Provides leverage for adjusting your dock. Winch slides over dock post. Winch kit pipe has a 2" inside diameter.

part# DAPW



**End Caps** **R V S C F**

Hewitt rubber caps are tough and very durable. They help cover sharp edges and fit snug to ensure they stay in place. This rubber material has a UV inhibitor to protect it from the elements.

**Round Rubber Pipe Caps**

ID	Part Number
1"	D1RC1
1-1/4"	D1RC1/4
1-1/2"	D1RC1/2
2"	D1RC2
2-11/16"	D1RC211/16



**Square Rubber Caps**

Size	Part Number
1-1/2" square	D1RC1SQ
2" square	D1RC2SQ
3" square	D1RC3SQ
2" x 5" square	D1RC5SQ



**Square Plastic Hole Plugs**

Size	Part Number
1-1/2" square	D1PC1SQ
2" square	D1PC2SQ
3" square	D1PC3SQ



**Rubber Post Plug**

Size	Part Number
2" square	LCGBPLUG



**Post Ratchet** **R V S C F**

Provides leverage to easily install and remove pipes with augers. This 19" handle and reversible ratchet fits pipes up to 1-3/4" O.D. Special order ratchets available for fitting pipes up to 2-1/4" O.D.

part# DAPR



# Dock Bumpers

 Indicates this product is shippable via UPS.

## 8' Bumpers **R V S C F**

To protect your boat and all around your dock area. Extra rugged design withstands heavy impact. Our 8' bumpers are built to last. They will not crack, rot or deteriorate when exposed to temperature extremes. A UV inhibitor prevents yellowing and discoloring from sunlight. The rub rails are also unaffected by oil, gas or salt water.



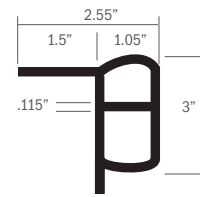

**8' Vinyl Bumper**

 part# D1BU8



**8' Hewitt Custom Bumper**

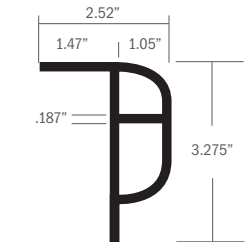

 part# D1BU8HW (WHITE)  
 part# D1BU8HB (BLACK)



## 2" x 2" Angle Bumper **R V S C F**



**Angle Bumper**

12'  part# LBUAN12  
 14'  part# LBUAN14

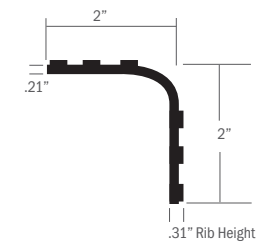

## 36" Adjustable Side Bumpers

Durable plastic bumper mounted on a 2" x 2" aluminum tube (largest in the industry) with your choice of aluminum mounting hardware. This setup is completely adjustable.

**Pipe Mount**

 part# D1BUVP

**R S C F**

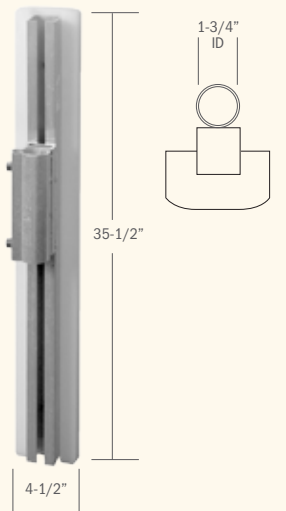

**Large Pipe Mount**

 part# D1BUVL

**R F**

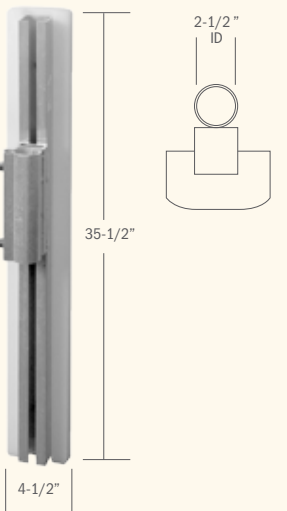

**Deck Mount**

 part# D1BUVD

**R S F**

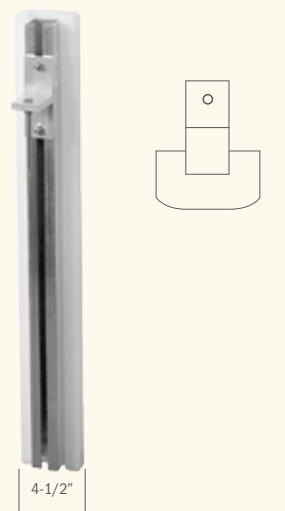

**Side Mount**

 part# D1BUVS

**R F**

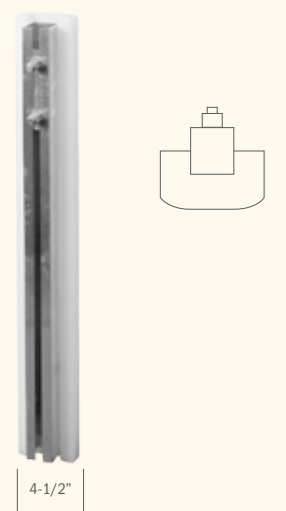

**Sectional Mount**

 part# D1BUVV

**R V S C F**

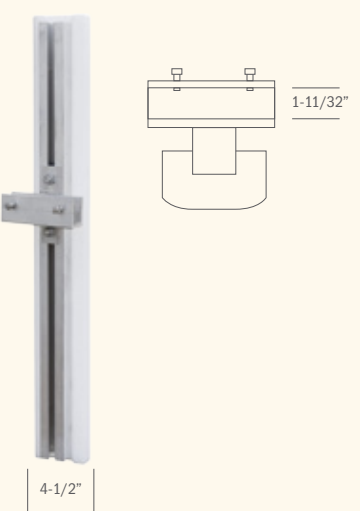



**R**oll-A-Dock



**V**ers-A-Dock



**S**ectional



**C**lassic dock



**F**loating Dock

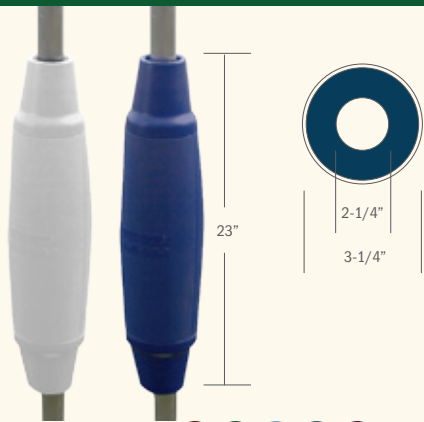

**Post Bumper** **R V S C F**

Designed to slide over dock pipe and wrap around support stand bracket to protect boat from rubbing on dock. Post bumpers are made of marine grade vinyl with UV and anti-fungal protection. Includes air valve for added protection.

- Blue part# D1BUB
- White part# D1BUW

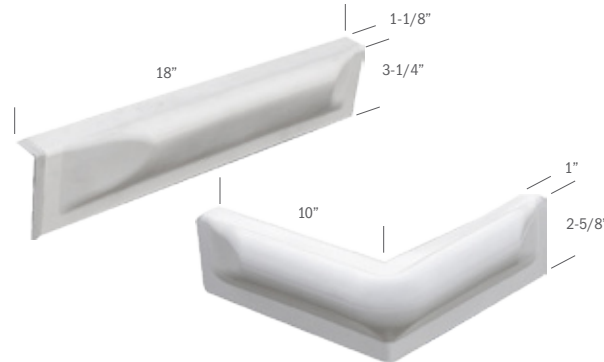

**Corner & Straight Bumper** **R V S C F**

Our corner and straight bumpers are made to protect your water vehicles from the most unforgiving part of the dock. The sculpted sides and nose provide an attractive finish with plenty of surface for easy mounting. These bumpers are made from marine PVC and are designed to be both soft and strong. Provides great cushioning under impact and will always return to its original form. Includes UV inhibitors.

*(Also available in black.)*

- 18" straight bumper part# D1BUS
- 20" corner bumper part# D1BUC

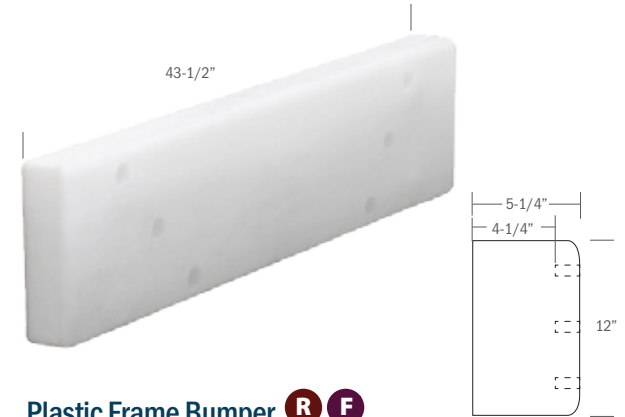

**Plastic Frame Bumper** **R F**

Made from durable polyethylene with UV inhibitors to provide long lasting durability that will not scratch or mark boat surfaces. Molded-in recessed mounting holes make the frame bumper easy to mount to docks and sea walls.

- White part# D1BUFR
- Black part# D1BUFRB

**Bumper Screws** **R V S C F**

Use to securely fasten bumpers to the dock frame with a large .455" head.

- Bag of 50 (self tapping) part# D1BUSC



**36" Round Edge Guard** **R V S C F**

These bumpers are molded from a stiffer formulation to handle larger watercraft than our smaller dock bumpers. There are three recessed mounting holes molded into this bumper for easy installation. They are rotationally molded for long lasting quality. Bumpers are made with marine grade PVC with UV and anti-fungal protection, will not fade, tear or become waterlogged. Install using up to a 3/8" inch lag or bolt with a nut and washers.

- White (without lip) part# D1BUEW      Black (without lip) part# D1BUEB
- White (with lip) part# D1BUELW      Black (with lip) part# D1BUELB

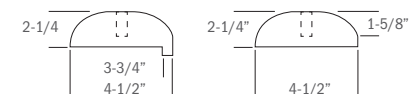
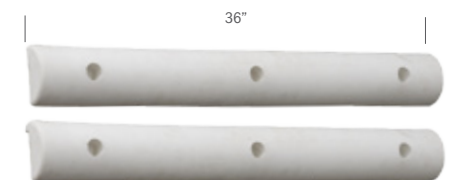

# Dock Ramps, Corner Triangles & Decking

 Indicates this product is shippable via UPS.

## Roll-A-Dock Ramp **R**

Used for the transition between the dock and your shoreline. This ramp features a tip-over design. No need to unbolt the ramp at the end of the season or when moving around docks. Simply flip it over! Four decking options available.

-  4' x 4'      6' x 4'
- 4' x 8'      6' x 8'
- 4' x 12'

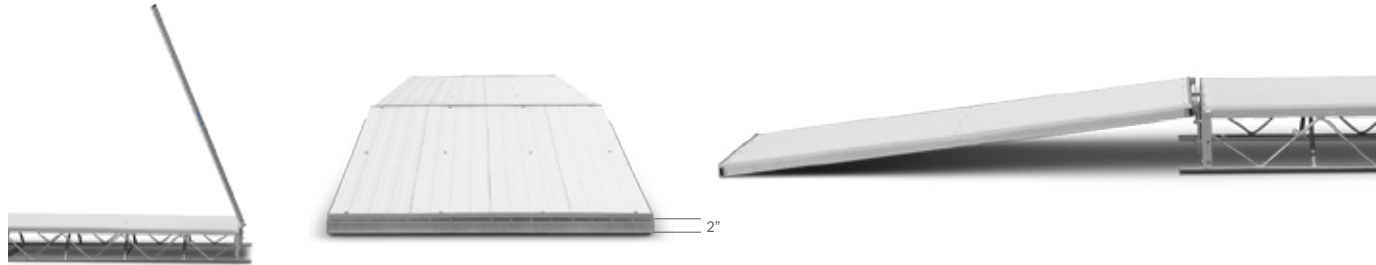

## Sectional Dock Ramp **S**

Used for the transition between the dock and your shoreline. Three decking options available; includes hinge kit; drilling required.

-  4' x 4'      6' x 4'
- 4' x 8'      6' x 8'

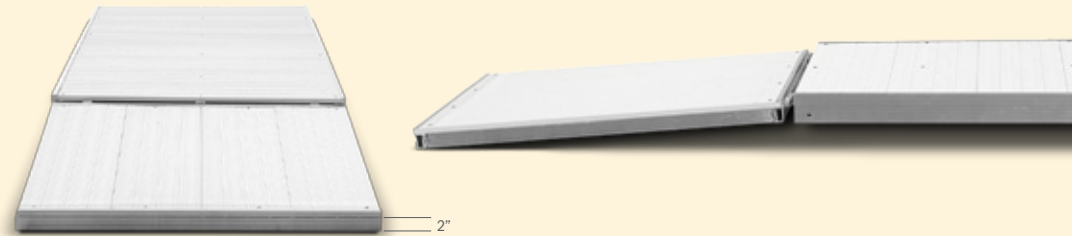

## Vers-A-Dock Ramp **V**

Used for the transition between the dock and your shoreline. Three decking options available; includes hinge kit.

-  4' x 4'
- 4' x 8'



## Classic Dock Ramp **C**

Used for the transition between the dock and your shoreline. Three decking options available; includes hinge kit.

-  4' x 4'
- 4' x 8'

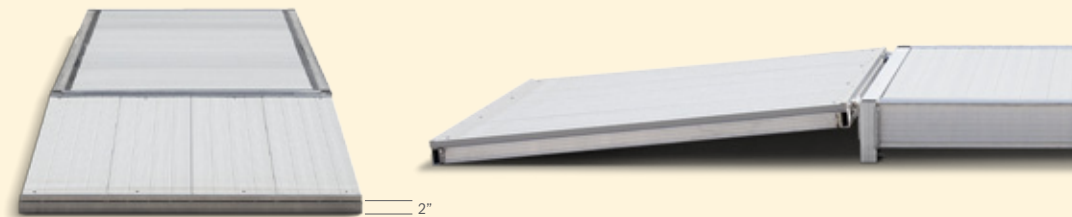



**R**oll-A-Dock



**V**ers-A-Dock



**S**ectional



**C**lassic dock



**F**loating Dock

### 4' Triangle Corners **R** **F**

Triangle corners for truss frame docks have a 2" frame with choice of four decking docks options. Aluminum and cedar (shown right). 



### 4' Classic Dock Triangle Corner **C**

Classic Dock triangle corner has a 5" classic extruded frame with choice of three decking options. ThruFlow decking, shown right, is one option available. 

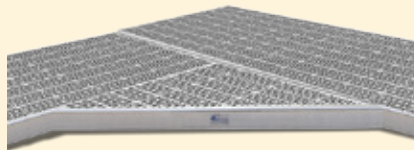

### 4' Vers-A-Dock Triangle Corner **V**

Vers-A-Dock triangle corners have a 2" frame with choice of 3 decking options. Shown to the right is a Vers-A-Dock with aluminum decking. 

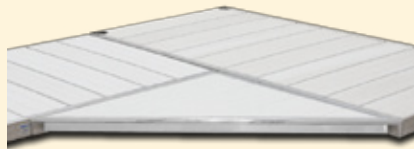

### Interlocking Aluminum Decking System

This option is well suited for custom-made docks, dock additions, platforms and ramps. Its interlocking design allows quick assembly and prevents the passage of water, making it ideal for second level observation decks and patios. The system consists of three basic parts: a starter section with mounting flange, tip-in center sections which can be added in any number to create the desired width, and an end section with mounting flange. Decking can be cut to length and capped off with aluminum channel. Deck sections are made from low weight, high strength extruded aluminum with a baked-on skid resistant finish, available in white or beige.

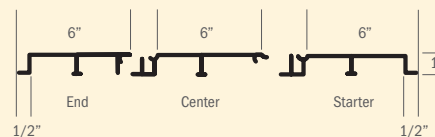
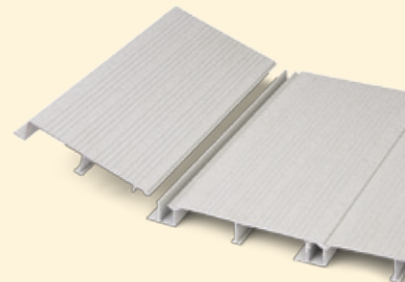

### Decking Options

Hewitt offers several different decking options. Each style is unique. Let us help you decide what best fits your needs. Hewitt can customize your dock with any of these listed materials. If you have any questions, please contact your local dealer.

*\* not available on 6' wide docks.*



**Cedar.** A traditional favorite. Solid, durable wood that is naturally weather resistant. Cedar boards come in 5/4" radius smooth planks.



**Skidguard.** A waffle-weave textured panel with a heavy-duty phenolic overlay. Skidguard provides a continuous, no-gap surface that is highly resistant to peeling or chipping.\*

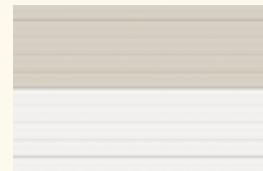

**QT Powder Coated All-Aluminum.** Extruded aluminum decking that offers superior strength, low weight and corrosion resistance. Incorporates sound deadening material and a baked-on beige or white finish for a durable nonskid surface.

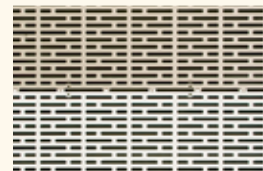

**ThruFlow.** Reinforced polypropylene finished decking system, designed for easy assembly that requires no maintenance. Its strong, durable, lightweight design makes for a perfect finish on our docks. ThruFlow allows water and debris to fall through your dock surface.



# Dock Wheels & Accessories

 Indicates this product is shippable via UPS.

## Dock Hitch

Heavy duty aluminum hitch for easier dock removal or installation. Attach to an SUV, lawn mower or ATV.

- 4' wide  part# D1HITCH
- 6' wide  part# D6HITCH



## Swivel Wheel

Heavy duty galvanized steel swivel wheel for shore end of dock. Used to maneuver dock around objects.

- 4' wide swivel wheel  part# D1HSW



## Fixed Shore End Helper Wheel







Attaches to shore end of dock to help with dock installation or removal. Wheels allow you to remove your dock without lifting or carrying it over rocks and other rough terrain. Helper wheel adjusts to two height positions.

- 4' wide aluminum  part# D1HSA
- 6' wide aluminum  part# D6HSA



## Adjustable Shore End Helper Wheel

Attaches to shore end of dock to help with dock installation or removal without lifting or carrying over rocks or other rough terrain.

- 4' wide aluminum with 3' tall pipe  part# D1HSAA3
- 6' wide aluminum with 3' tall pipe  part# D6HSAA3
- 4' wide aluminum with 5' tall pipe  part# D1HSAA5
- 6' wide aluminum with 5' tall pipe  part# D6HSAA5
- 4' wide aluminum with 8' tall pipe  part# D1HSAA8
- 6' wide aluminum with 8' tall pipe  part# D6HSAA8

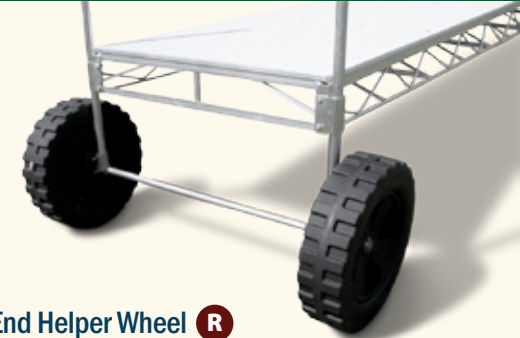



**R**oll-A-Dock



**V**ers-A-Dock



**S**ectional



**C**lassic dock



**F**loating Dock

### Standard Polyethylene Storage Box

With molded handles and double walled lid. Water and dust resistant. Lockable hasp also included.

part# L1HYPB



### Large Polyethylene Storage Box

With stainless handles and double walled lid. Water and dust resistant. Lockable hasp also included.

part# L1HYPBL



### Deep Water Kit

Replaces the standard wheel assembly to adjust up to 8'.

- 4' Aluminum part# DDEEPA
- 4' Galvanized part# DDEEPG
- 6' Galvanized part# D6DEEPG



### Deep Water Extensions

Converts the standard 4' wide wheel assemblies to accommodate 8' water depths by making it telescope (cutting required). Replaces the standard wheel assembly to adjust up to 8'.

- 48" Aluminum part# DDEEPA3-3



### Helper Wheel for "L" **R**

Attaches to dock ends to assist in removing or installing "L" or "T" dock sections.

- 4' wide aluminum with 5' upright part# D1HLA
- 4' wide aluminum with 8' upright part# D1HLA8
- 6' wide aluminum with 5' upright part# D6HLA
- 6' wide aluminum with 8' upright part# D6HLA8

### 8' Helper Wheel for "L" **R**

Attaches to sides of 8' sections to assist in removing or installing "L" or "T" dock sections.

- 8' wide aluminum with 5' upright part# D8HLA
- 8' wide aluminum with 8' upright part# D8HLA8

\* Recommended use of 3" x 3" cap for 4', 6' & 8' models. See page 9.



# Ladders & Steps

 Indicates this product is shippable via UPS.

## Heavy-Duty All-Aluminum Ladder **R V S C F**

Ladder constructed of heavy-duty 1-1/2" square aluminum to resist corrosion. Ladder features 3-1/2" extruded aluminum channel serrated to produce a non-skid surface rung with no sharp edges. Ladder rated 665 lb per rung.

- 4 steps  part# D1LADA4
- 4 steps (2 piece)  part# D1LADA42
- 6 steps  part# D1LADA6
- 6 steps (2 piece)  part# D1LADA62

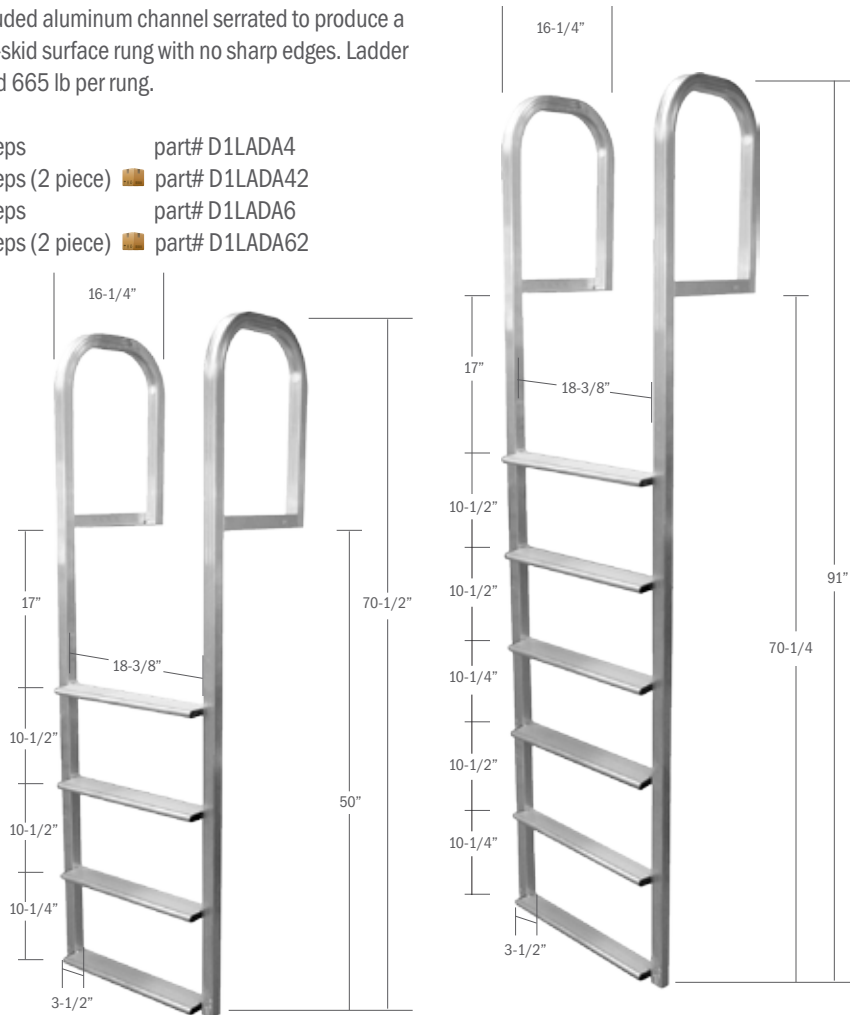

## Mounting

Hardware for mounting 4 and 6 step ladders.

-  part# D1LADM



## Aluminum Ladder Hinges **R S F**

Aluminum hinge allows you to swing ladder to an upright position. (Drilling required in ladder.)

- One pair  part# D1LADH



## Mini Raft Ladder

This unique raft ladder is constructed with 100% high-density polyethylene (no rusting or wearing), and a one-piece, seamless rotational-molded design. Contemporary designed ladder features include: rounded handles with molded-in finger grips (pinch-free and no sharp edges), non-slip deck pattern for easy raft access, and our quick and effective 4-bolt attachment system (bolts provided).

-  part# D1PSRMLG

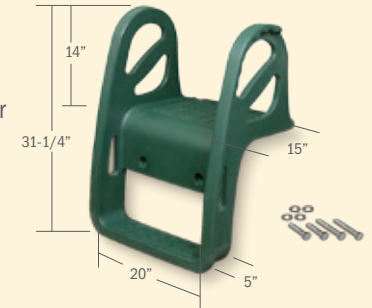

## Wave Armor Ladder

This unique ladder is constructed with 100% high-density polyethylene. This dock ladder integrates perfectly with the Wave Armor system. Folds up and out of the water when not in use. Bottom section of ladder floats.

-  part# DF21961

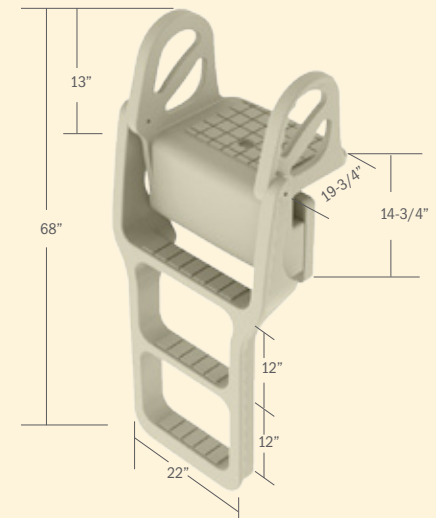





**R**oll-A-Dock



**V**ers-A-Dock



**S**ectional



**C**lassic dock



**F**loating Dock

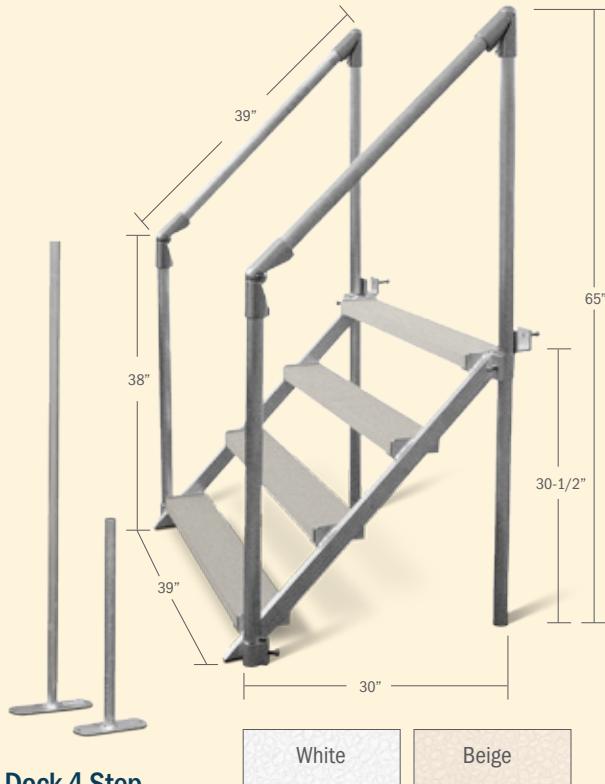

White Beige

**Dock 4 Step**

These all aluminum steps offer a 2" x 6" powder coated tread, ideal for young children to the elderly. Ensures safe entrance or exit from the water. The step system comes with attachment bracket that fits most docks and two 23" front legs with pads.

- Dock 4 Step - White      part# D1STEP4
- Dock 4 Step - Beige      part# D1STEP4B
- Dock 4 Step 23" Legs (Pr)      part# D1STEP4L
- Dock 4 Step 52" Legs (Pr)      part# D1STEP4L52

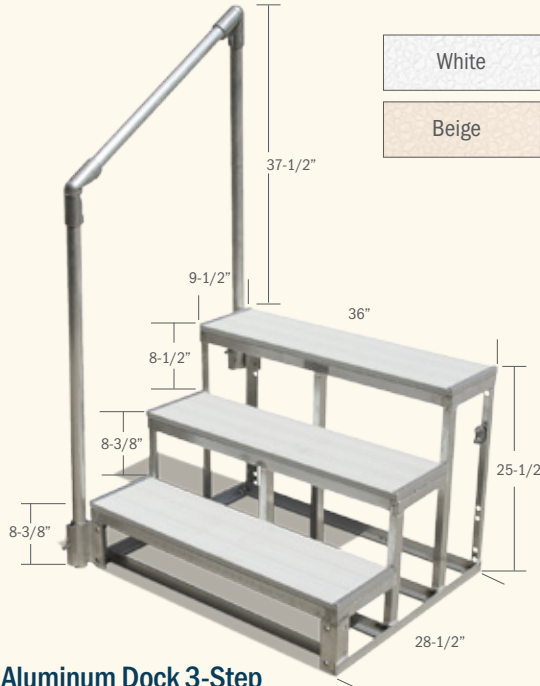

White Beige

**Aluminum Dock 3-Step**

Easy access for areas with a rise from the shore to the deck of the dock. Aluminum dock steps are all welded frame and steps.

- Dock 3 step stairs      part# D1STEPB
- Dock 3 step with railing      part# D1STEPWRB
- Dock 3 step stairs      part# D1STEP
- Dock 3 step with railing      part# D1STEPWR



White Beige

**Adjustable Steps**

The All-Terrain staircase is made entirely of corrosion resistant aluminum. All components are ruggedly constructed, yet lightweight, for easy handling and assembly. Stair treads and landings are made from the same high-quality QT powder coated aluminum decking that is available on Hewitt Docks. The baked-on finish provides sure footing even when wet.

- 3' Adjustable steps (3' to 4-1/2')      part# D1STEPA3
- 5' Adjustable steps (5' to 7-1/2')      part# D1STEPA5
- 3' Adjustable steps (beige 3' to 7-1/2')      part# D1STEPAB3
- 5' Adjustable steps (beige 5' to 7-1/2')      part# D1STEPAB5

**Adjustable Dock to Step Bracket R**

Used to mount Hewitt adjustable steps to side or end of Roll-A-Dock. Custom brackets available for other docks. The adjustable dock step bracket allows for ascending or descending scenarios.

- part# D1STEPDMB



# Float Tanks & Otter Accessories

 Indicates this product is shippable via UPS.

## Float Tanks **F**

Used to construct a floating dock or raft. Also useful for adding sections to an existing dock. 25 different sizes available.

“The most important component of your floating dock is the flotation that keeps the dock floating.”

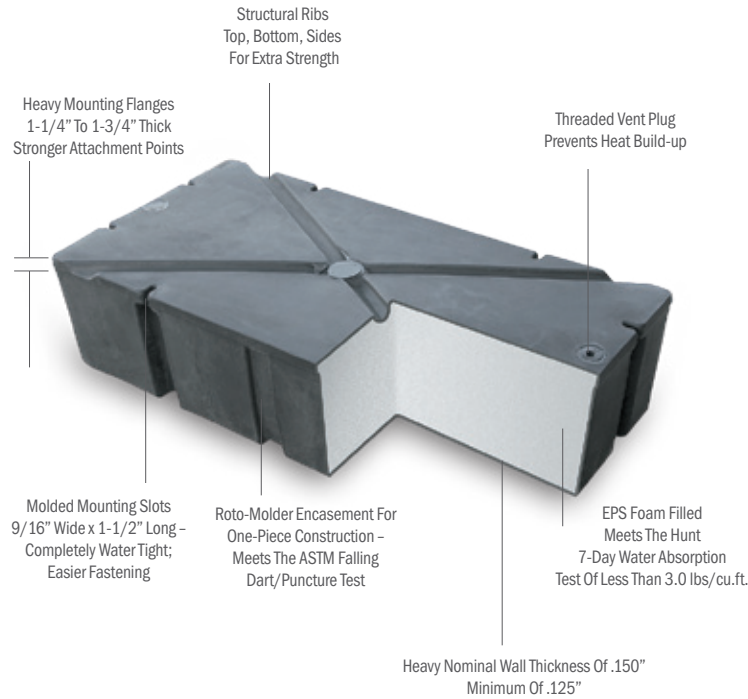

What you can't see is vital to the performance of our floating docks! Unarguably the most sought after floats (based on sales volume) in the marina market are from Premier, because they meet ALL of the important design, engineering, manufacturing, shipping, storage and installation standards that give you the best performance and value.

One piece molded rotational drum: Foam filled, molded in mounting slots, heavy-duty mounting flanges, air relief vent, 8 year limited warranty (*non-prorated*).











## Float Tank Brackets **R**

Brackets for connecting float tanks to a Roll-A-Dock frame. Includes hardware. Part number includes one pair for one float.

- 4' Galvanized  part# D1FBS42
- 6' Galvanized  part# D1FBS62



Model	Size (Inches)	Cu. Ft.	Wt. (lbs)	Float Buoy.
<b>Series 1248</b>				
 #1248-20	12" x 48" x 20"	6.7	28	340
<b>Series 2072</b>				
 #2072-8	20" x 72" x 8"	6.7	35	380
<b>Series 2436</b>				
 #2436-08	24" x 36" x 8"	4	23	230
 #2436-12	24" x 36" x 12"	6	27	335
 #2436-16	24" x 36" x 16"	8	31	440
 #2436-20	24" x 36" x 20"	10	36	540
<b>Series 2448</b>				
 #2448-08	24" x 48" x 8"	5.3	26	310
 #2448-12	24" x 48" x 12"	8	32	450
 #2448-16	24" x 48" x 16"	10.7	38	590
#2448-20	24" x 48" x 20"	13.3	44	725
#2448-24	24" x 48" x 24"	16	50	860
#2448-36	24" x 48" x 36"	24	70	1215
<b>Series 2496</b>				
#2496-8	24" x 96" x 8"	9.6	52	600
<b>Series 3242</b>				
#3242-18	32" x 42" x 18"	14.2	46	790
<b>Series 3648</b>				
#3648-12	36" x 48" x 12"	12	43	685
#3648-16	36" x 48" x 16"	16	52	900
#3648-18	36" x 48" x 18"	18	59	1016
#3648-20	36" x 48" x 20"	20	64	1110
#3648-24	36" x 48" x 24"	24	74	1315
#3648-32	36" x 48" x 32"	32	80	1729
<b>Series 4848</b>				
#4848-12	48" x 48" x 12"	16	56	920
#4848-16	48" x 48" x 16"	21.3	68	1215
#4848-20	48" x 48" x 20"	26.7	79	1500
#4848-24	48" x 48" x 24"	32	93	1775
<b>Series 4860</b>				
#4860-12	48" x 60" x 12"	20	64	1155
#4860-16	48" x 60" x 16"	26.7	81	1525
#4860-20	48" x 60" x 20"	33.3	102	1885
#4860-24	48" x 60" x 24"	40	114	2235
<b>Series 3672</b>				
#3672-12	36" x 72" x 12"	18	65	1035
#3672-16	36" x 72" x 16"	24	78	1365
#3672-20	36" x 72" x 20"	30	90	1685
#3672-24	36" x 72" x 24"	36	105	1995
#3672-32	36" x 72" x 32"	48	115	2640
<b>Series 4272</b>				
#4272-12	42" x 72" x 12"	19.5	70	1210
#4272-16	42" x 72" x 16"	28	87	1600
<b>Series 4872</b>				
#4872-12	48" x 72" x 12"	24	83	1390
#4872-16	48" x 72" x 16"	32	98	1835
#4872-20	48" x 72" x 20"	40	113	2270
#4872-24	48" x 72" x 24"	48	132	2695
#4872-32	48" x 72" x 32"	64	173	615
<b>Series 4896</b>				
#4896-12	48" x 96" x 12"	32	110	1855
#4896-16	48" x 96" x 16"	42.7	134	2455
#4896-20	48" x 96" x 20"	53.3	154	3040
#4896-24	48" x 96" x 24"	64	176	3615
<b>Boat Lift Series</b> (All .375 Wall Thickness)				
#252 BLAT	26" x 30" x 60"	27	85	1000
#183 BLAT	30" x 30" x 90"	46.9	130	2000
#242 BLAT	32" x 40" x 108"	81.5	200	3700

A Superior 12-Year Warranty, with the first 8 years 100% non-prorated.



**R**oll-A-Dock



**V**ers-A-Dock



**S**ectional



**C**lassic dock



**F**loating Dock

### Otter Island Umbrella

Patio style retractable umbrella easily fits inside the raft table mounting hole.

part# DF11914

### Otter Island Seat Cushion

This padded seat fits over the backrest and provides a comfortable seating surface. Made of durable quick-dry fabric and foam.

part# DF11904



### Kayak Rack

A sturdy and stylish kayak rack is a great solution for waterfront storage. Features molded-in kayak hook receivers to secure kayak to rack. Attaches to Wave Armor Dock or special brackets available for mounting to truss or wood docks.

part# DF21960

### Kayak Rack & Brackets

part# DF21961

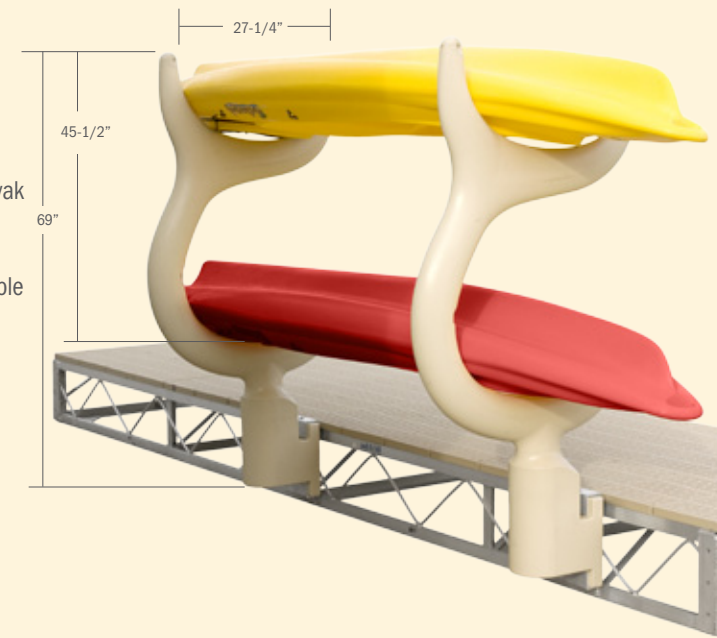

### Raft Anchor Bungee Kit

Contains 33\"/>

part# D1PSRBK

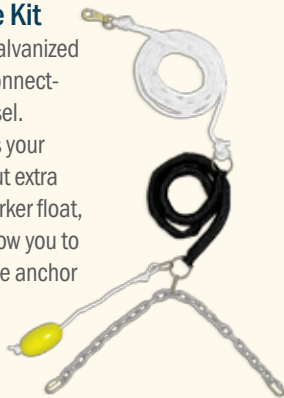

### Otter Island Raft Anchor

Made of 100% high-density polyethylene. Just fill it with sand and this 140 lb anchor will keep your raft where you want it.

part# D1PSRA



### Raft Anchor Clevis Kit

This complete hardware kit is designed for quick, easy attachment of an anchor to your Otter Island or Mini Raft, using rope or chain. The kit includes a 32\"/>

part# D1PSRAC



# Pontoon Conversions & Accessories

 Indicates this product is shippable via UPS.

## Pontoon Rack Kit

Convert your regular lift into a pontoon lift with these heavy-duty aluminum brackets and hardware. Rack lifts under the boat's deck, adds life to the boat's tanks. Also useful as a landing guide to center your boat over the lift. There are two different rack styles, (shown top right) pontoon rack with wood, (shown bottom right) aluminum adjustable rack kit.

Standard Rack Kit: 1800 Wide, 2400-5200 Cantilever  
 Medium Rack Kit: 1800 Roll-A-Rail, 1600-3800 Hi-Lifter  
 Medium Rack Kit: 4600HL  
 Large Rack Kit: 5600HL, 6600HL

**Wood Bunks**  
 part# LNPRKS  
 part# LNPRKM  
 part# LNPRKM46  
 part# LNPRKL

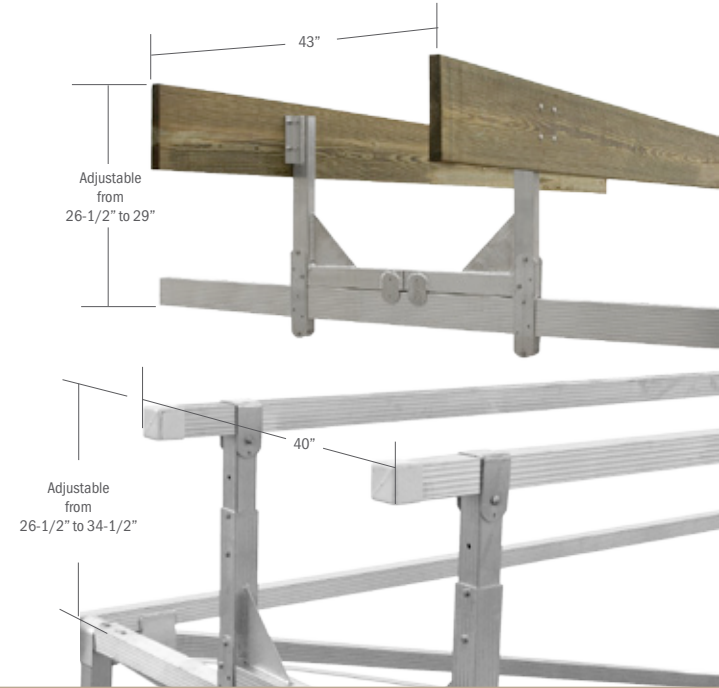

**Aluminum Rack**  
 part# LNPRKAS  
 part# LNPRKAM  
 part# LNPRKAM46  
 part# LNPRKAL

\* Aluminum adjustable rack kit works on tritoons.



## Narrow Pontoon Offset Winch Arm Extension

Use to bring winch closer to dock for easier operation.

For 2000 & 2000NP  part# NANP1606  
 For 3000NP  part# NANP3006

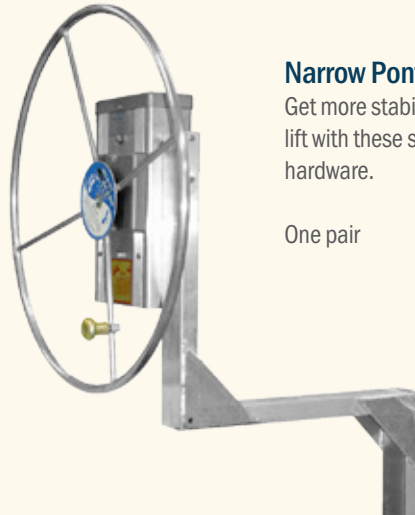

## Narrow Pontoon Stabilizer Bars

Get more stability out of your narrow pontoon lift with these stabilizer bars. All aluminum with hardware.

One pair  part# LNPSB

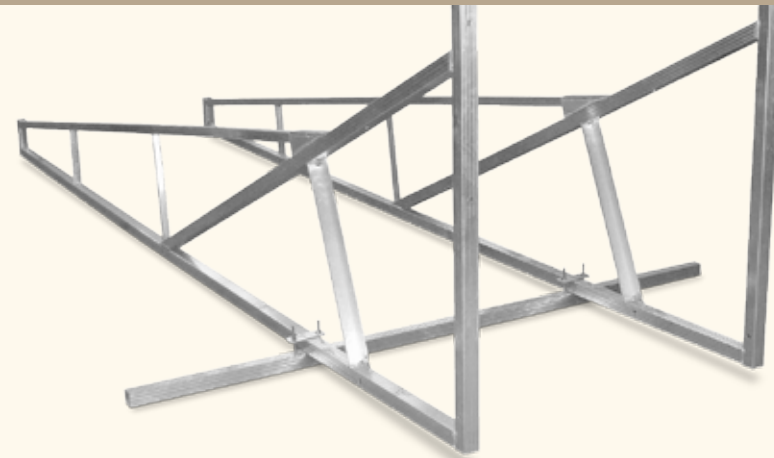

Various shapes and sizes of aluminum are available for sale. Contact your local dealer for details.

### Vinyl Pontoon Bed

Convert your regular lift into a pontoon lift using the 14' vinyl bunks, to be installed in a "V" shape. This vinyl bed fully cradles your pontoons.

#### One set

1800-5200 Cantilevers  
1600-4600 Hi-Lifter

#### Twin Tube

part# LNPCVB  
part# LNPCVBH

#### Triple Tube

part# LNPCVB1/2  
part# LNPCVBH1/2



### Carpeted Pontoon Wood Bed

Convert your regular lift into a pontoon lift using the 14' carpeted bunks, to be installed in a "V" shape. This wood bed fully cradles your pontoons.

#### One set

1800-5200 Cantilevers  
1600-4600 Hi-Lifter

#### Twin Tube

part# LNPCWB  
part# LNPCWBH

#### Triple Tube

part# LNPCWB1/2  
part# LNPCWBH1/2



### Aluminum Pontoon Bed

Convert your regular lift into a pontoon lift with these pontoon bed brackets. Aluminum pontoon bed kits lift the boat by the pontoon tanks.

#### One Set

1800-5200 Cantilevers  
1600-4600 Hi-Lifter

#### Twin Tube

part# LNPAPB  
part# LNPAPBH

#### Triple Tube

part# LNPAPB1/2  
part# LNPAPBH1/2

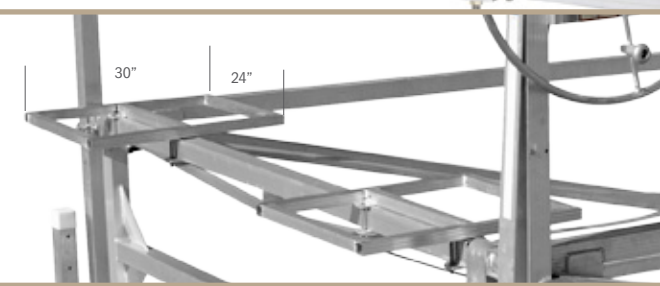

### Narrow Pontoon Guide Roller

This guide bolts onto a 3" tube. Roller aids in guiding boat onto lift.

One pair part# LNPGR



### Narrow Pontoon Front Stops

Stop pontoon from overrunning lift.

One pair part# LNPFS

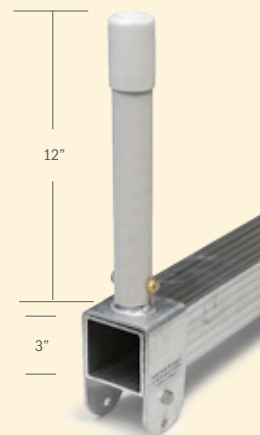

### Narrow Pontoon Cat Walk

Allows easy access to front of boat while on lift.

part# LNPW

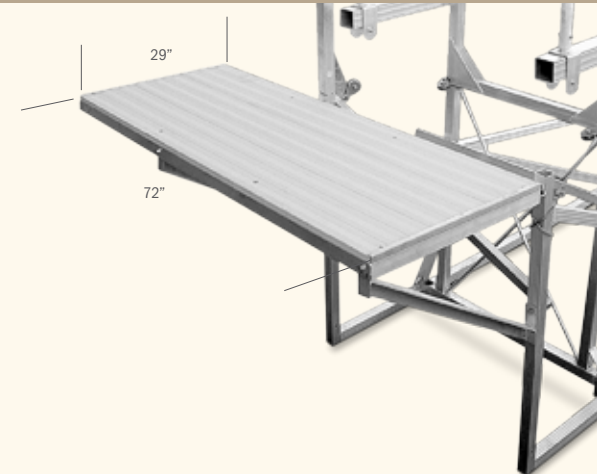

# Lift Bumpers, Centering Guides & Motor Stop

 Indicates this product is shippable via UPS.

## 36" Plastic Bumpers

This high strength plastic is made to be stiff, yet forgiving. The low density properties give it the ability to cushion impact then return to form. Formulated with UV protection for the marine environment, it is both long lasting and extremely durable. Mounts to most square poles with recessed mounting holes. Also available in black.

- 2" slot  part# D1BUPV2
- 3-1/2" slot  part# D1BUPV3

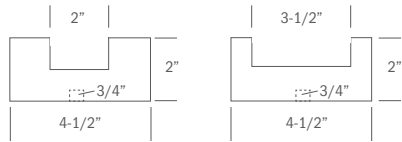

## 36" Locking Arm Bumper

This bumper slides over the Boat-Port locking arm upright to act as a bumper/centering guide.

- White  part# D1BUVA
- Black  part# D1BUBAB

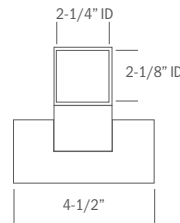

## Foam Post Bumper

Bumper slides over 1-1/2" OD pipe and also serves as replacement foam for centering guides.

-  part# D1BUF

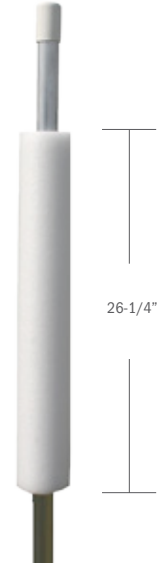
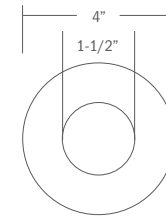

## 36" Plastic Centering Guides

These guides feature shock absorbing rubber bushings at the base and durable plastic bumpers. Standard fits up to 3" wide by 3" tall beds

Hi-Lifter fits up to 3" wide by 5" tall beds

-  part# LCGBP

Hi-Lifter fits up to 3" wide by 5" tall beds

-  part# LCGBPHL



## Heavy-Duty Centering Guides

The names says it all. Our heavy-duty centering guides feature shock absorbing springs at the base and durable plastic bumpers that won't mar your boat's finish. Fits tubes up to 3-3/4" w x 8" h.

part# LCGBHD

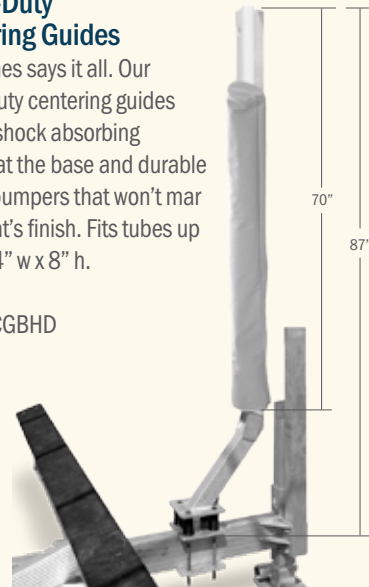

## Hydraulic Motor Stop

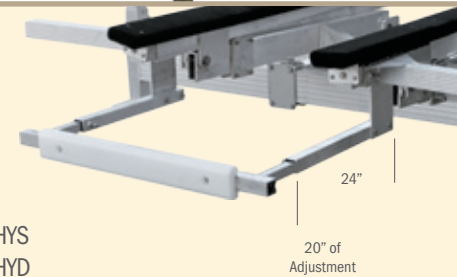

Protect your motor from overrunning your hydraulic lift. Offers 20" of adjustment.

- Single Motor  part# LMSHY5
- Double Motor  part# LMSHYD



## Motor Stop

Protect your motor from overrunning the lift.

- Small  part# LMS
- Large Adjustable  part# LMSL

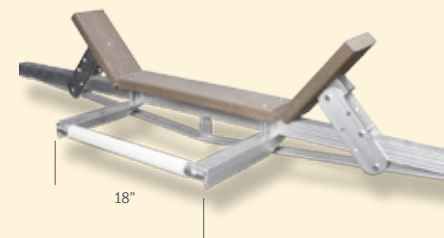

Various shapes and sizes of aluminum are available for sale. Contact your local dealer for details.

### Boat Port Side Walk Brackets

Bolts onto Boat Port cross-beams to create a side walkway.

part# LBPWB

2- tank lift uses 4 brackets per side  
3- tank lift uses 5 brackets per side

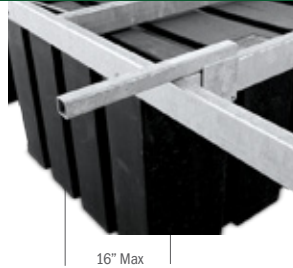

16" Max

### Full-Length Guide Step

Full-length guide steps aid in guiding your boat into the same position every time. Vertical and horizontal adjustment support for getting in and out of your boat.

12' Standard for 1800 - 5200  
14' Standard for 1800 - 5200  
12' Medium for 1600 - 4600  
14' Medium for 1600 - 4600  
12' Large for 5600 - 6600 HL  
14' Large for 5600 - 6600 HL

#### Carpeted

part# LFLCG  
part# LFLCG14  
part# LFLCGH  
part# LFLCGH14  
part# LFLCGHL  
part# LFLCGHL14

#### Deluxe

part# LFLCGA  
part# LFLCGA14  
part# LFLCGAH  
part# LFLCGAH14  
part# LFLCGAHL  
part# LFLCGAHL14

### Boat Port Front Walk Brackets

Bolts onto front of Boat Port to create a side walkway. One needed per side.

One Pair part# LBPWBF

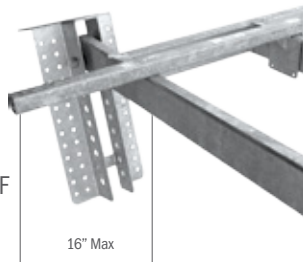

16" Max



### Bow Stops

Bow stops are used for rough water or outdrive ski boats to keep boat from overrunning the lift.

Hydraulic Stop (drilling required) part# LBSHY  
Standard Stop part# LBS

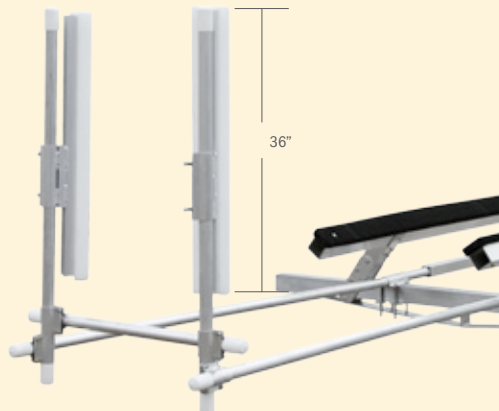

36"

### Hydraulic Full-Length Outriggers

Allows you to install guides onto hydraulic lifts. Keep in mind, two pair are needed – one pair for each side of lift. If using motor stop, only one pair is needed.

One pair part# LFLCGHYB

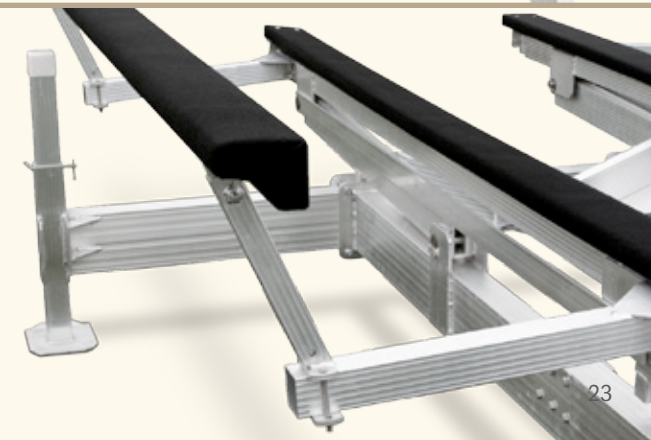

# Hand Winches, Wheels & Catwalks

 Indicates this product is shippable via UPS.

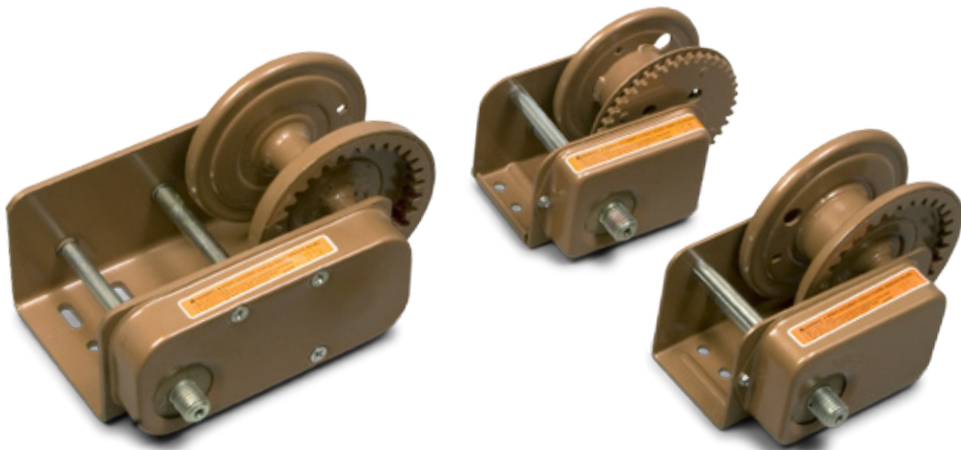



## Braking Winches: replacement or upgrade

These braking winches have a completely enclosed gear box with a large cable spool. Crank one way to go up, crank the other way to go down. Stop in any position without flipping a lever.

B-1200	Gear Ratio 4:1	 part# LWB12
B-1500	Gear Ratio 6:1	 part# LWB15
B-2500	Gear Ratio 12:1	 part# LWB25

## Hand Winch

This is a non-braking winch with a one-way ratchet system.

B-1100	Gear Ratio 3.9:1	 part# DWINCH
Crank handle		 part# D304016

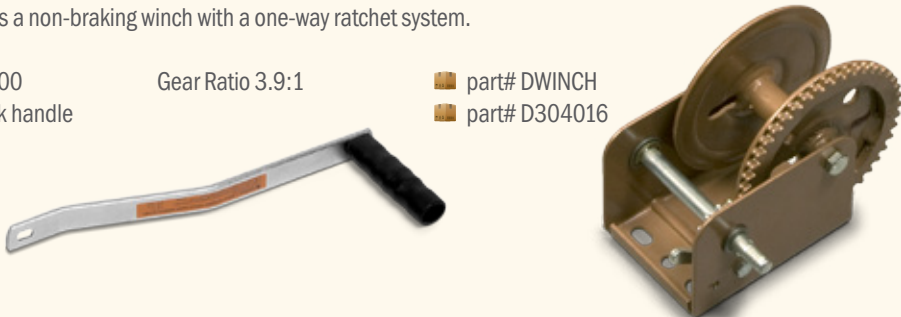

## Winch Top Cover



Protect your winch from the elements with a winch cover.

Hewitt Winch Top Cover  part# LWHWC



## Hewitt Chain Driven Winch

This chain driven, gear reduced, self-braking winch has an all aluminum casing that lets you raise and lower your boat with ease.

1501: 15 to 1 ratio	 part# LHHW15
2001: 20 to 1 ratio	 part# LHHW20
2501: 25 to 1 ratio	 part# LHHW25

## Winch Gear Cover

For Hewitt 1501-2001 winch.

 part# LHHWGC

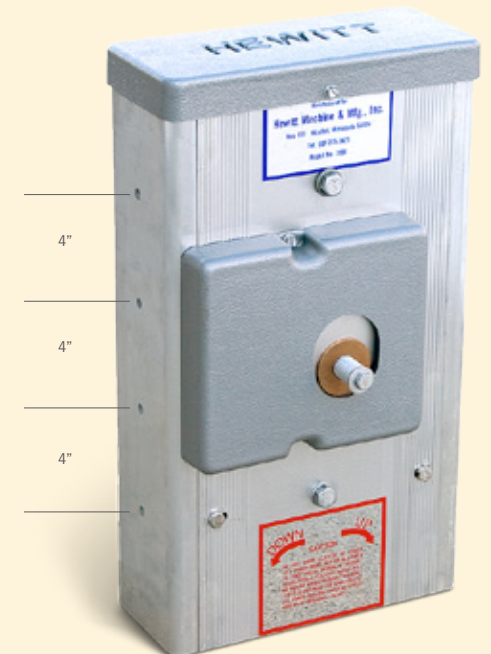



Various shapes and sizes of aluminum are available for sale. Contact your local dealer for details.

### Double Pulley Conversion Kit

For 3000 lb lift. Converts lift to 3600 lb capacity.

part# L1PCO



### Catwalk

All aluminum brackets with mounting hardware, to make side mounted catwalk for cantilever and hydraulic lifts with canopy or free standing canopies (planks not included).

One Pair part# LCWB

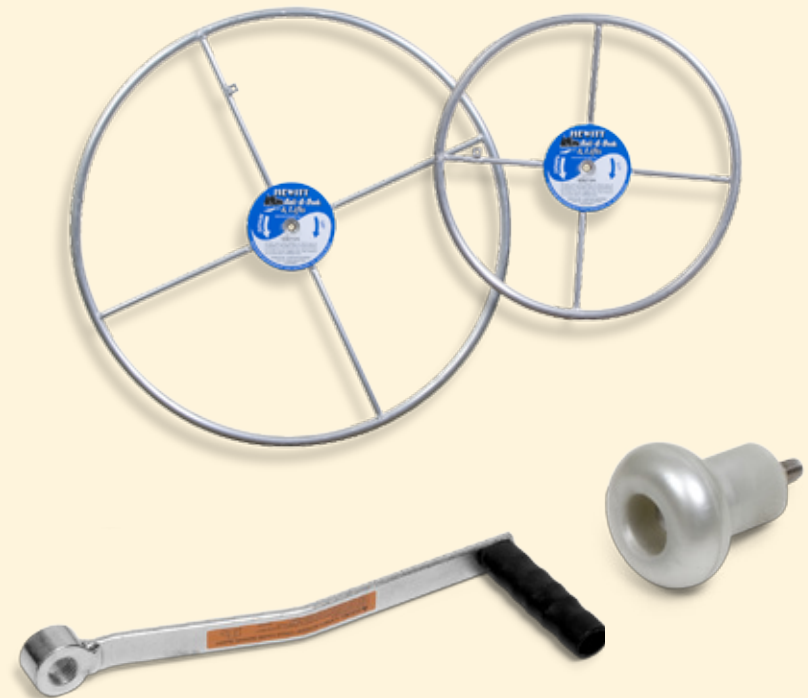
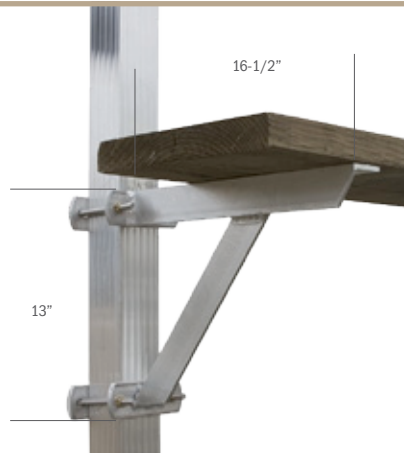

### Crank Handle & Large Wheels

For less fatiguing manual winch operation. For DL, B1200, B1500, B2500, 1501, 2001, 2501 winches.

Crank handle  
30" Aluminum wheel  
40" Aluminum wheel  
Spinner knob with hardware

part# LWWCH  
part# LWWs  
part# LWWL  
part# LKNOB

# Heavy-Duty Electric Hoists & Hewitt<sup>2</sup> Electric Hoist

 Indicates this product is shippable via UPS.

## Heavy Duty Electric Hoists

Hewitt Heavy Duty Electric Hoists are an alternative to the manual winch. They feature a heavy-duty worm drive powered by a 115V AC motor. High-strength, precision machined components allow these hoists to be rated for higher lifting capacities than competitive brands. Available in three models for capacities of 2000, 4000 and 6500 lbs. Corresponding hoist speeds are 4.0, 2.5 and 3.0 feet/minute. Cast gears, pulleys, motors and wire gauge are specifically sized to the capacity. Hoists include a protective cover, weatherproof wiring and a baked-on powder coated finish. 12 volt option available.

### Cable Drum

### Box Drum



## Heavy Duty Motor Remote

Is built with a manual up and down push button, or use the two wireless remote key fobs included. Heavy duty motor remote has an auto stop plug that allows you to add a mechanical limit switch to stop the motor at a specific boat lift height.

 part# LRMR



Capacity	Motor	Vertical Speed per Min	Weight	Wiring	Plate	Gear	Part #
2000 lbs	3/4 H.P.	4.0	62 lbs	14 ga.	9-1/2" x 19-1/2"	8"	 LWHP2 (w/cable drum)
4000 lbs	1 H.P.	2.5	78 lbs	14 ga.	12" x 24"	12"	 LWHP4 (w/cable drum)
4000 lbs	1 H.P.	2.5	78 lbs	14 ga.	12" x 24"	12"	 LWHP4B (w/box drum)
6500 lbs	1 H.P.	3.0	99 lbs	14 ga.	12" x 24"	12"	 LWHP6 (w/cable drum)
6500 lbs	1 H.P.	3.0	99 lbs	14 ga.	12" x 24"	12"	 LWHP6B (w/box drum)

Various shapes and sizes of aluminum are available for sale. Contact your local dealer for details.

## Hewitt<sup>2</sup> Direct Drive

The Hewitt<sup>2</sup> Boat Lift Direct Drive System takes the place of the standard winch wheel. It features convenient remote control operation and dock lighting for added safety. The unit is quick and easy to install and is available in AC and DC versions. For use on lifts up to 6000 lb lifting capacity. Brackets available for all lift brands. Hewitt<sup>2</sup>'s double sealed motorshaft, sealed electrical box, and o-rings around the rivets allow for extra protection from the elements. This unit includes a two piece cover. Please ask your dealer for details.

### AC Unit

Drive unit, AC non-remote control box with key, or AC remote control box complete with key and two wireless remote control key fobs, and canopy light. Also an AC & DC motor crank for system back-up and mounting hardware.

### DC Unit

Includes 12 or 24V DC drive unit, non-remote control box with key or DC remote control box complete with two wireless remote control key fobs, canopy light, and jumper cables. Also AC & DC motor crank for system back-up and mounting hardware.

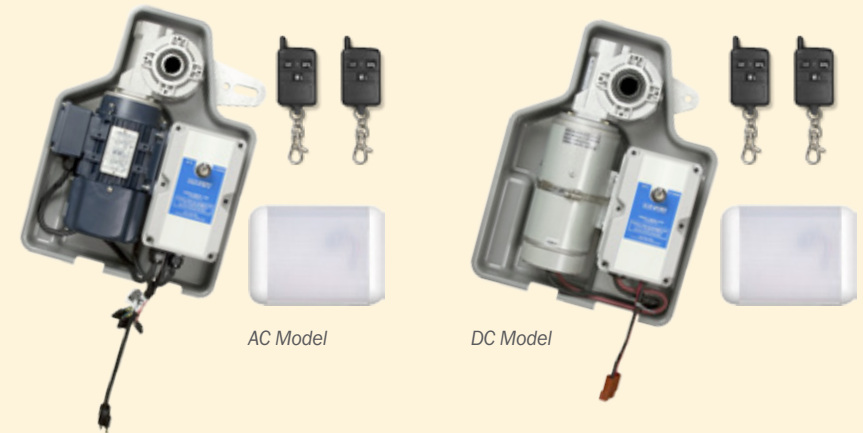

### Buck Booster

Used when electrical wiring is inadequate or if faster lifting time is desired with the AC Turnkey. AC Models ONLY!

part# LWHDDB



### Mechanical Limit Switch

Mechanical spring driven limit switch prevents from overlifting your boat on lift. AC/DC Models with remote ONLY!

part# LWHDDSS



### Illuminator

Add more lighting to your dock system. This system provides an extra 110V Outlet. AC Models with remote ONLY!

part# LWHDDI



### Back Up-Bit

Allows you to raise and lower your lift with a standard drill. Back-up bits come standard with all AC & DC Hewitt<sup>2</sup> Motor Kits.

part# LWHDDES



### Motor

AC 110V Unit w/Remote  
AC 110V Unit w/Key Switch  
DC 12V/24V Unit w/Remote  
DC 12V/24V Unit w/Key Switch

### RPM

56  
60  
58 at 12V  
96 at 24V  
58 at 12V  
96 at 24V

### Current Draw

7-16 AMPS  
9-11 AMPS  
40-80 AMPS at 12V  
20-40 AMPS at 24V  
40-80 AMPS at 12V  
20-40 AMPS at 24V

### Part #

LWHDD110  
LWHDDSS110  
LWHDD12  
LWHDDSS12

# Solar Panels, Battery Stands & Canopy Accessories

 Indicates this product is shippable via UPS.

## Solar Panel Battery Charger

These 10 watt & 20 watt solar panels offer outstanding performance even in cloudy conditions. This charger will efficiently keep your marine battery charged without overcharging. Rugged enough for year-round installation.

**10 Watt Dimensions: 13-1/2" x 11"**

**20 Watt Dimensions: 24-1/2" x 11"**

10 Watt Solar Panel System  
*(Includes Solar Panel And Stand)*

 part# LSPP10

20 Watt Solar Panel System  
*(Includes Solar Panel And Stand)*

 part# LSPP20

10 Watt Solar Panel Only

 part# LSP10

20 Watt Solar Panel Only

 part# LSP20

Solar Panel Stand only

 part# LSPS10



## 24-Volt Solar Regulator Kit

This kit allows you to connect one solar panel to two batteries and prevents overcharging.

 part# LSPR24

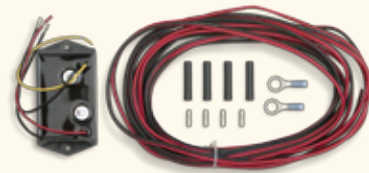

## Battery Box Stand

These battery box stands keep your marine batteries off your dock and out of the way.

### 12V Stand

*Clamps to square or round tube*

 part# L1HYBBS

### 24V Stand

*Bolts on, drilling required.*

 part# L1HYBBS24

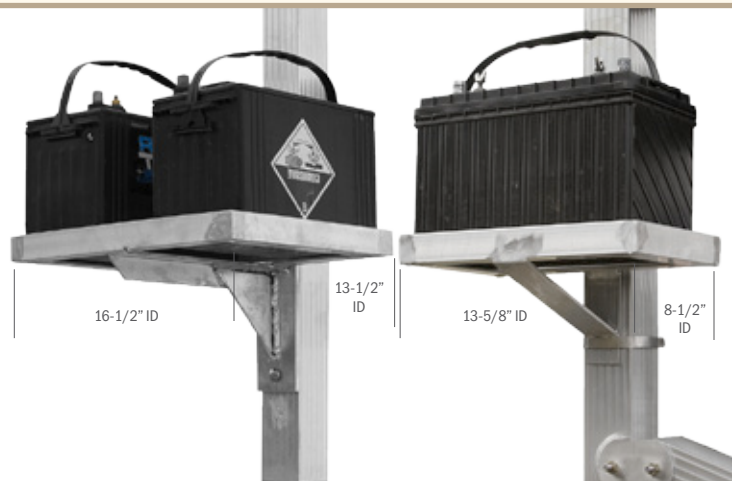

## Kill A Watt

Simply plug in Kill A Watt to evaluate the quality of the electrical power provided from your utility company, by monitoring voltage, live frequency and power factor. Perfect for detecting voltage drops and brownout conditions before they damage delicate equipment.

 part# LWMETER

Various shapes and sizes of aluminum are available for sale. Contact your local dealer for details.

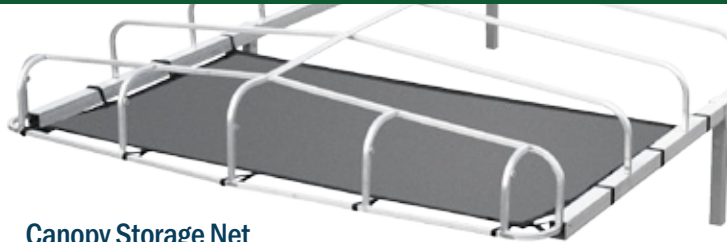

### Canopy Storage Net

Storage net creates storage under your canopy. Net protects gear from sun, rain, wind, and theft. Installs with quick release clips in minutes. No tools required. Makes boating much more enjoyable. Turn your canopy into a boathouse today.

Size	Width	Part #
Small	96" - 107"	part# LDCS1096
Medium	108" - 120"	part# LDCS1108
Large	121" - 138"	part# LDCS1138

### Canopy Bracing

Used to support canopies 29' and up. Completely adjustable with the telescoping extension.

part# LDCB



### Lift Jack

The "Original" lift jack allows you to raise one end of the lift to easily adjust lift legs and assist with installing/removing lift wheels without going under water. Lift jack handle is 36".

#### Lift Jack

(with non-braking winch)

part# LWJ

#### Lift Jack

(with braking winch)

part# LWJB



### Canopy Repair Kit

Did you have an accident and puncture your canvas? No problem. This canvas repair kit is easy to use for permanent repairs of small holes and tears in your vinyl canvas. This patch kit comes with a 4 oz can of adhesive with brush and one 1/4 square yard of vinyl in your color choice.

part# REPAIR(color)



### Transportation Bar

Use a boat to move lift in and out of deep water or to a new location.

part# LWTRAN



### Winch Arm Extensions

Length	For Model	Part#
14" (3" x 3")	3000 - 4200	part# NAMWEXT14
18" (2-5/8" x 2-5/8")	3800 HL - 4600 HL	part# NAMWEXT18



### Tension Cords

Tired of tying canvas to your canopy frame and cutting knots when you remove the canvas? Then tension cords are the answer! Quick and easy.

Set of 40

part# LDR



# Lift Wheels & Bunks

 Indicates this product is shippable via UPS.

## Corner Assist Wheel Kit

Makes lift installation and removal much easier: they're quick to set up, lightweight, easy-to-use, and may be used on several lift sizes without permanent attachment.

1200-1800 Cantilever

2400-4800 Cantilever

1100-6600 Hi-Lifters

4100-10100 Hydraulic (*Bracket slides over leveling leg*)

-  part# LWCS
-  part# LWCL
-  part# LWCH
-  part# LWCHY



Cantilever



Hi-Lifter



Hydraulic

## Retractable Wheel Kit

Why break your back carrying your lift in and out of the water every season? These wheels stay permanently attached to your lift. To operate, simply attach the chains to the lift bed and crank the lift up.

Standard size wheel kit  
(for 1200-2400)

 part# LWR

Standard size wheel Hi-Lifter kit  
(for 1100-2600 HL)

 part# LWRH

Large size wheel kit  
(for 2400W-4800)

 part# LWRL

Large size wheel Hi-Lifter kit  
(for 3800 - 6600 HL)

 part# LWRHL



## Lift Wheel Kit

Mounts on center of lift. Works great for maneuvering around objects or over sea walls.

For cantilever lifts

 part# LWK

For narrow pontoon lifts

 part# LWKNP



## Hydraulic Bunk Wheel Kit

Mounts on sides of hydraulic bunks. Wheel kit works with one simple button. Push down button on your remote and you're ready to go.

 part# LWKHY



## Hydraulic Lift Arm Wheel Kit

Mounts on the lift arms. Wheel Kit works with one simple button. Push down button on your remote and you're ready to go.

 part# LWAHY





Various shapes and sizes of aluminum are available for sale. Contact your local dealer for details.

### Deluxe Rubber Cradles and Keels

Cradles sold in pairs (2).

1800, Roll-A-Rail, 1600 HL to 4600 HL  
1800 wide, 2400-4800 Cantilever  
Rubber Keel

-  part# LCRD22
-  part# LCRD32
-  part# LCRDKP



### PWC Bunk Upgrade

Aluminum Tube with extruded non-scratch plastic glides with a UV protection. Per Pair.

2" x 4" x 84"  
for 900, 1150, 1790, 2300 PWC

2" x 6" x 10'  
for 1200, 1500, 1800 PWC

 part# L1PWB9

 part# L1PWB26



### PWC End Caps

45° Protective Rubber End Cap.

One Pair  part# L1PWBP1

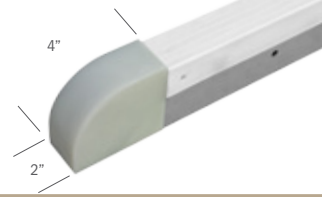

### Deluxe Bunks

All aluminum 2" x 2" bunk with an extruded ribbed rubber surface. Bunks sold in pairs (2).

Length	Part #
12'	LFLBA12
14'	LFLBA14

### Aluminum Rubber Bunks

All aluminum 3-1/4" x 3-1/4" bunk with an extruded ribbed rubber surface. Bunks sold in pairs (2).

Length	Part #
12'	LBAR12
14'	LBAR14

### Carpeted Full-Length Bunks

Full-Length Bunks are made from pressure treated lumber and covered with premium grade marine carpeting. Carpeting is highly resistant to mildew and rot. Bunks sold in pairs (2).

Size	Length	Part #
2" x 6"	12'	LFLB12
2" x 6"	14'	LFLB14
2" x 10"	12'	LFLBL12
2" x 10"	14'	LFLBL14

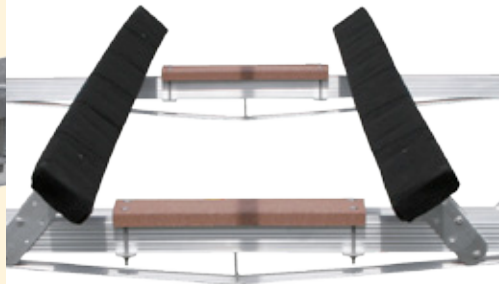

### Aluminum V-Bunk

Solid 3" x 3" aluminum tube with a carpeted, pressure treated bunk or 3-1/4" x 3-1/4" aluminum with rubber bunk used on all outdrive ski boats. Bunks sold in pairs (2).

Length	Wood Part #	Rubber Part #
12' Standard 1800 wide - 5200 cantilever	LVBA	LVBAR12
14' Standard 1800, 1600 - 3800HL	LVBA14	LVBAR14
12' Medium 1800, 1600 - 3800HL	LVBAH	LVBARH12
14' Medium 1800, 1600 - 3800HL	LVBAH14	LVBARH14
12' Large 5600 - 6600HL	LVBAHL	LVBARHL12
14' Large 5600 - 6600HL	LVBAHL14	LVBARHL14



Shown with wood.



Shown with rubber.

# Lift Legs & Extensions

 Indicates this product is shippable via UPS.

## Leveling Legs

A variety of lengths of leveling legs are available to assure level lift installation in deep water or on an uneven lake or river bed.

- 18" long 1-1/2" x 1-1/2" sq.  part# LL182 – for 900, 1150 and 2300 PWC
- 30" long 1-1/2" x 1-1/2" sq.  part# LLH30
- 36" long 1-1/2" x 1-1/2" sq.  part# LL132 – for 900, 1150 and 2300 PWC
- 60" long 1-1/2" x 1-1/2" sq.  part# LL152
- 36" long 2" x 2" sq.  part# LL232
- 72" long 2" x 2" sq.  part# LL262
- 96" long 2" x 2" sq.  part# LL282
- 36" long 3" x 3" sq.  part# LL332
- 72" long 3" x 3" sq.  part# LL362
- 96" long 3" x 3" sq.  part# LL382
- 30" long 2-5/8" x 2-5/8" sq.  part# LLH32
- 72" long 2-5/8" x 2-5/8" sq.  part# LLH62
- 96" long 2-5/8" x 2-5/8" sq.  part# LLH82
- 84" long 3" x 3" sq.  part# LLH72

\*See page 9 for rubber caps.

## Leg Pins and Setscrew for Leveling Legs

For quick and easy height adjustments to leveling legs.

- 1/2" x 1-1/2" setscrew  part# LLSS
- 2-1/2" leg pin with clip  part# LLP2/2
- 3-1/2" leg pin with clip  part# LLP3/2
- 4" leg pin with clip  part# LLP4
- 4-1/2" leg pin with clip  part# LLP4/2

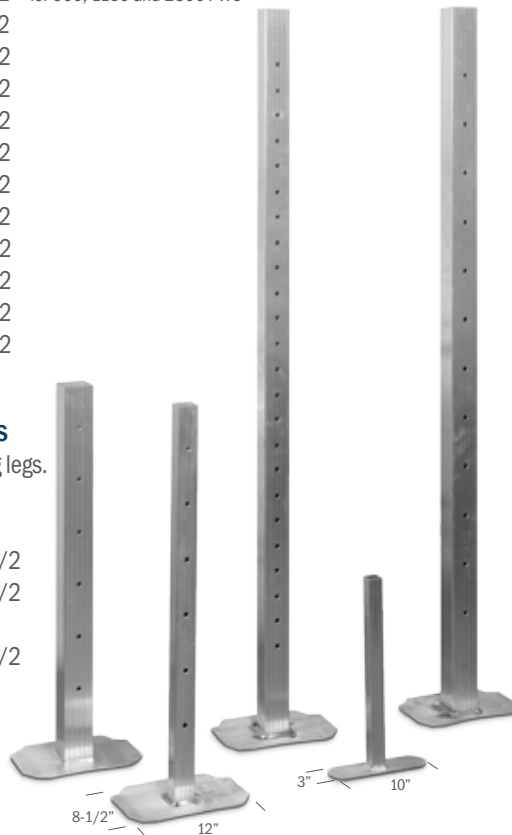

## 3"x3" Adjustable Screw Leg

Have fluctuating water? The adjustable screw legs mount on the outside of lift and operate with a simple cordless drill. 30" of total adjustment. Fits Cantilever Lifts 2000-4800lbs.

3' x 3'  part# LLSA



## Hi-Lifter Adjustable Screw Leg

Replaces existing leveling leg. The Hi-lifter adjustable screw legs mount on the outside of lift and operate with a simple cordless drill. 30" of total adjustment. Fits Hi-Lifts 2600-5600lbs.

2-5/8" Legs  
without exchange  part# LLSAHL  
with exchange  part# LLSAHLX

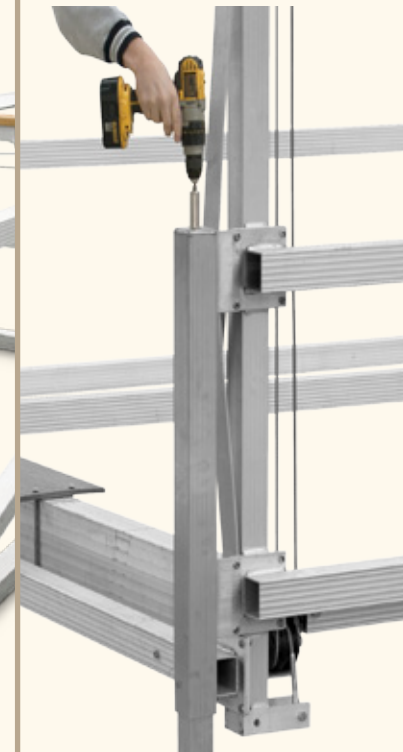

## Leveling Legs Extensions

Add onto existing leveling legs without buying a whole new leg.

2" x 2"  part# LL2E  
3" x 3"  part# LL3E





Various shapes and sizes of aluminum are available for sale. Contact your local dealer for details.

### Hydraulic Pump Box Stands

Mounts over 3" x 3" square tube and keeps your hydraulic pump off your dock and out of the way.

- Standard Box  part# L1HYPBS
- Large Pump Box  part# L1HYPBS24



### Hydraulic Hose Extension Kit

Hoses make it quick and easy to move your pump box away from lift or into a boathouse. 11' extension, 2 hoses.

-  part# NAHYHE





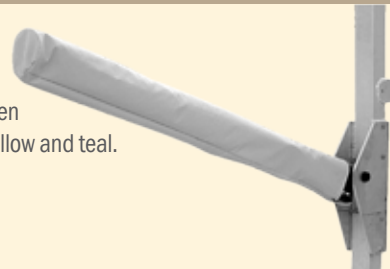

### Cylinder Sleeves

Dress-up vinyl sleeve for cylinders on hydraulic cantilever lifts. Available in seven colors: grey, beige, blue, white, green, yellow and teal. Also available in SeaMark fabric.

-  part# LHYCS - Color





### Replacement Key Fob

- ROWE (top)  part# LWHYK
- COMMANDER (bottom)  part# LWHYKC
- COMMANDER replacement battery  part# LWHYRBC
- ROWE replacement battery  part# LWHYRB



### Lighting Kit







For hydraulic lifts. Includes: 2 low voltage, submersible lights with 20 watt halogen bulbs (3,000 hour average life), 20' cord and four colored lenses (yellow, red, blue and green). 110V model also includes transformer.

- 110V  part# LTK110
- 12V  part# LTK12



### Leveling Leg Bracing

Used to stabilize long leveling legs. Price includes parts for two legs.

- 2" x 2" for 1800 Cantilever  part# LL2BR
- 2" x 3" for 2400 Cantilever  part# LL2BR24
- 3" x 3" for 3000-4800 Cantilever  part# LL3BR
- 2-5/8" x 3" for 2600-6600 Hi-Lifter  part# LLHBR
- 4100, 6100, Hydraulic  part# LLHYBR
- 8100, 10100, 12,100 Hydraulic  part# LLHYBR8



### Large Aluminum Pad

Gives leveling legs greater support in soft or sandy lake bottoms. Installs to bottom of existing pad. Drilling required for installation.

-  part# LLPAD

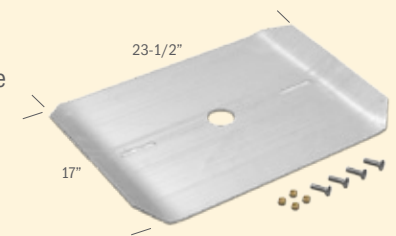



# Roll-A-Rail Accessories & Apparel

 Indicates this product is shippable via UPS.

## 5' Rail Cross Bar

Clamps onto bottom side of rail track. All aluminum 5' cross bar with adjustable 3' legs and pads. Recommended to be used for supporting rail every 8' if track leaves the ground. The 5' cross bar is used to support rail up to 4' above ground level. In instances that the elevation is above 4', use the 8' cross bar for support.

4500 lb  
6500 lb

 part# LRAL  
 part# LRALL

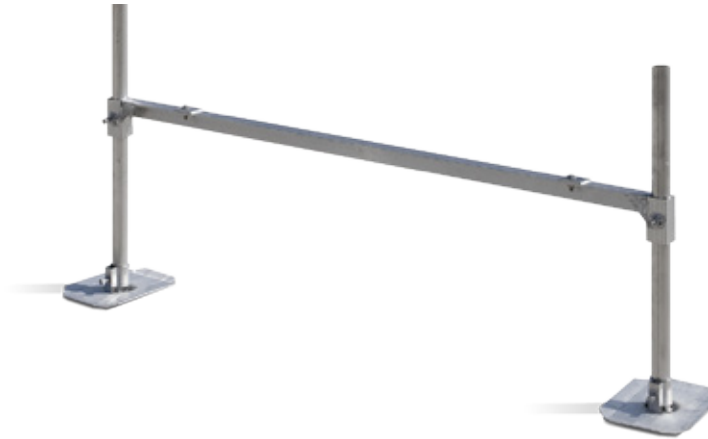

## Rail Cable Guides

Polyethylene guide prevents wear on braces when the degree or slope of land changes.

2 pieces

 part# LRACG

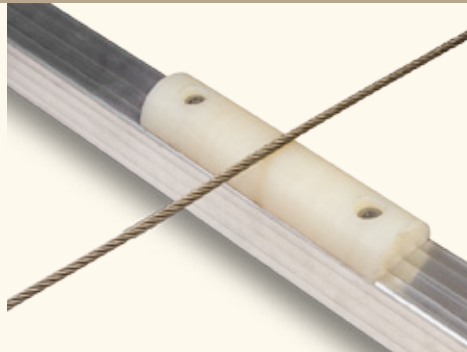

## Rail Remote

Need more range? Add a remote to an existing rail system. This remote system has a 200' range and includes two key fobs. Built with a manual up and down push button. Rail remote has an auto stop plug that allows you to add a mechanical limit switch to stop the rail cart at a specific location.

 part# LRMR



## Rail Tip-Up

Pivoting rail section allows garage or boat-house door to close completely.

 part# LRTUP

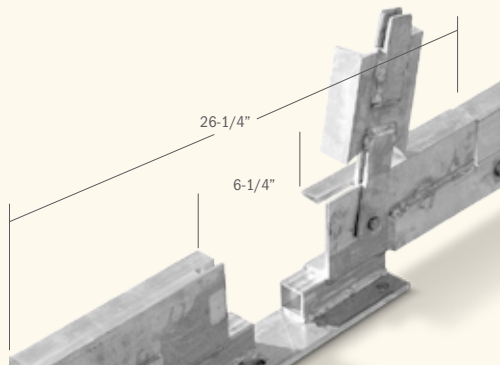

## Breaking Winch

Used on rail if incline is greater than 10° (1.6' in 16' elevations).

 part# LRMSB

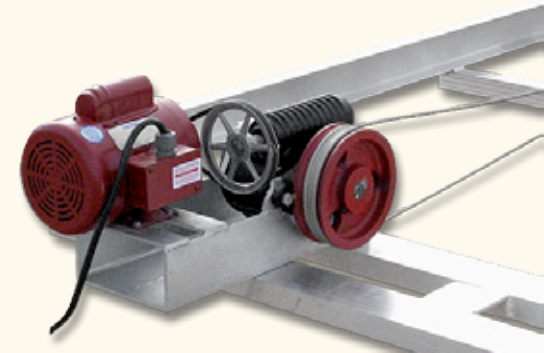

1. Embroidered baseball cap in colors shown.
3. Hooded sweatshirts in gold, gray, light blue.
5. Micro fiber pullover in black, putty, red (pontoonlegs/roll-a-dock logos available)
7. T-shirts, various colors – Screen-printed.

2. Polar fleece jacket in various colors.
4. Embroidered sweatshirt in two logo styles, various colors.
6. Long or short sleeve denim shirt.
8. Full-lined jacket in khaki or black.

1 A



1 B



1 C



2



3 A



3 B



4 A



5 A



5 B

6



7



4 B



8





We at HEWITT would like to thank you for your interest in our products. We are confident that you will find the service, quality, workmanship, and design of all HEWITT products to be the industry's finest. For over 40 years, boat and watercraft owners have trusted the safety and longevity of their investments to Hewitt Lifts, docks, and canopies.

#### LIMITED WARRANTY

New HEWITT-built accessories carry a 15 year conditional warranty on all aluminum and aluminum welds. 5 year conditional warranty on vinyl and SeaMark canvases, excluding fading.

HEWITT Machine and Manufacturing, Inc. further warrants all other parts used on HEWITT-built lifts and accessories, purchased new by original owner, to be free from defects in the material and workmanship under normal use for a period of 24 months from the date of purchase (excluding components and options which carry their own manufacturer's warranty, wherein that warranty will apply.) Warranty is void when misuse or neglect is the cause. Specifications are subject to change without notice. THIS WARRANTY IS VALID ONLY IN THE UNITED STATES AND CANADA FOR PRODUCTS USED FOR FRESH WATER. HEWITT PRODUCTS ARE NOT INTENDED FOR SALT WATER (with the exception of BoatPorts).

No other express warranty or guaranty, except as mentioned above, given by any person or entity with respect to HEWITT products shall bind HEWITT Machine and Manufacturing, Inc. This warranty supersedes all other warranties expressed or implied. NO IMPLIED WARRANTIES, INCLUDING ANY IMPLIED WARRANTY OF MERCHANTABILITY OR FITNESS FOR A PARTICULAR PURPOSE APPLY TO HEWITT PRODUCTS AND ARE HEREBY DISCLAIMED.

In the event of a possible warranty claim, the defective products must be returned to HEWITT Machine and Manufacturing, Inc. If proven to be defective upon inspection they will be exchanged for new or comparable rebuilt products, as determined by HEWITT Machine and Manufacturing, Inc. and shipped back to the original purchaser. All shipping costs are the responsibility of the customer. Warranty replacement shall not extend the original warranty period of the defective HEWITT products. HEWITT Machine and Manufacturing, Inc. must be notified in writing within one month of the expiration of the applicable period of the express limited warranty stated above for an item to be evaluated for warranty.

The customer's remedies with respect to defective HEWITT products shall be exclusively limited to the repair or replacement remedy as above provided and in no event shall HEWITT Machine and Manufacturing, Inc. be liable for loss of profits, revenues, savings, inconvenience, associated costs, expense for equipment or service, use of capital, facilities, services, storage charges, damage to property, or any other special, incidental or consequential damages caused by the use or misuse of, or inability to use, the HEWITT product, regardless of the legal theory on which the claim is based, and even if HEWITT Machine and Manufacturing, Inc. has been advised of such damages. In no event shall recovery of any kind against HEWITT Machine and Manufacturing, Inc. be greater in amount than the purchase price of the HEWITT product sold by HEWITT Machine and Manufacturing, Inc. and causing the alleged damage. Without limiting the foregoing, the purchaser assumes all risk and liability for loss, damage or injury to persons, animals or property arising out of use or misuse of, or inability to use, the HEWITT product. HEWITT Machine and Manufacturing, Inc. is not liable for third party claims. This limited warranty shall not extend to anyone other than the original purchaser of the HEWITT product, or the person for whom it was purchased as a gift, and states your exclusive remedy. In no event shall HEWITT Machine and Manufacturing, Inc. be liable for incidental or consequential damages to the full extent such may be disclaimed by law.

Unless otherwise noted this warranty agreement is the only warranty agreement between the parties. This agreement states the limits and association of risk between the two parties. Customer acknowledges understanding of this warranty and agreement and binding to the terms contained within.

#### OTHER MANUFACTURER'S WARRANTIES

Non HEWITT Machine and Manufacturing, Inc. manufactured products are sold "as is", without warranty of any kind by HEWITT Machine and Manufacturing, Inc., including an implied warranty regarding MERCHANTABILITY OR FITNESS FOR A PARTICULAR PURPOSE, and all such warranties are disclaimed. The sole warranty, if any, with respect to such non HEWITT Machine and Manufacturing, Inc. manufactured products is given by the manufacturer or producer thereof. Based upon HEWITT Machine and Manufacturing, Inc.'s knowledge the following warranties are provided by other manufacturers: Hydraulic hoses carry a manufacturer's 2-year warranty. Specifications are subject to change without notice.

PRINTED IN THE USA

#### HEWITT MACHINE AND MANUFACTURING INC.

709 Hwy 14 West, Nicollet, MN 56074

Weekdays, 7:30 am to 4:30 pm CST

Ph: 507.225.3421 or 800.544.2067

www.hewitt-roll-a-dock.com

Fax: 507.225.3053

Email: info@hewitt-roll-a-dock.com